

Polyurethane Timing Belts





Gates Mectrol

Passion for Products

OUR EXPERTISE

Gates Mectrol is a leading manufacturer of synchronous timing belts and other polymer based automation components. These components are typically used in conveying, linear positioning, rotary positioning and power transmission applications.

Equipment designers and system integrators have come to rely on Gates Mectrol's application expertise and ability to solve the most challenging design issues. Our highly skilled applications engineers and online suite of design tools can help solve your most demanding development concerns.

Get the Gates Mectrol engineering team working for you.

OUR ACCESSIBILITY

With manufacturing facilities and partner distributors located throughout the world, Gates Mectrol is available globally to serve your specific design challenges. Our associates know and understand our business — and yours.

OUR GOAL

Gates Mectrol's goal is to become your primary supplier of polymer based automation components. We will earn this position by offering quality products in a timely manner and by continuously developing new products and services.

IMAGINATION, DESIGN, EXECUTION

Polyurethane Timing Belts

Belt Selection Guide	4	Customized Belts	
Tooth Pitch Comparison	5	Profiled Belts Overview	24
Linear Belts		Design Recommendations	25
Linear Belt Overview	6	Backings	30
Linear Belt Applications	7	Backings Specifications	34
Linear Belt Specifications	8	Fabrication Capabilities	38
Imperial Pitch Belts	10	Truly Endless Belts	
T Pitch Belts	11	Truly Endless Belt Overview	40
AT Pitch Belts	12	Gates Synchro-Power® (Cast) Belts	42
HTD® and STD Pitch Belts	13	Flex Belts	45
SelfTracking Belts	14	Technical Chapter	
Wide Belts		Technical Design Tools Online	46
Wide Belt Overview	16	Calculation	47
Wide Belt Applications	17	Tension Meter	58
Wide Belt Specifications	18	Facilities	59
Flat Belts		Contact Information	60
Flat Belt Overview	20		
Flat Belts	21		
Flat Belt Specifications	22		
Design Recommendations	23		

Broadest Range Available



Changes due to continuous product development may occur



Belt Selection Guide

Linear Belts

Flat Belts

Wide Belts

Customized Belts

Truly Endless Belts

Technical Chapter

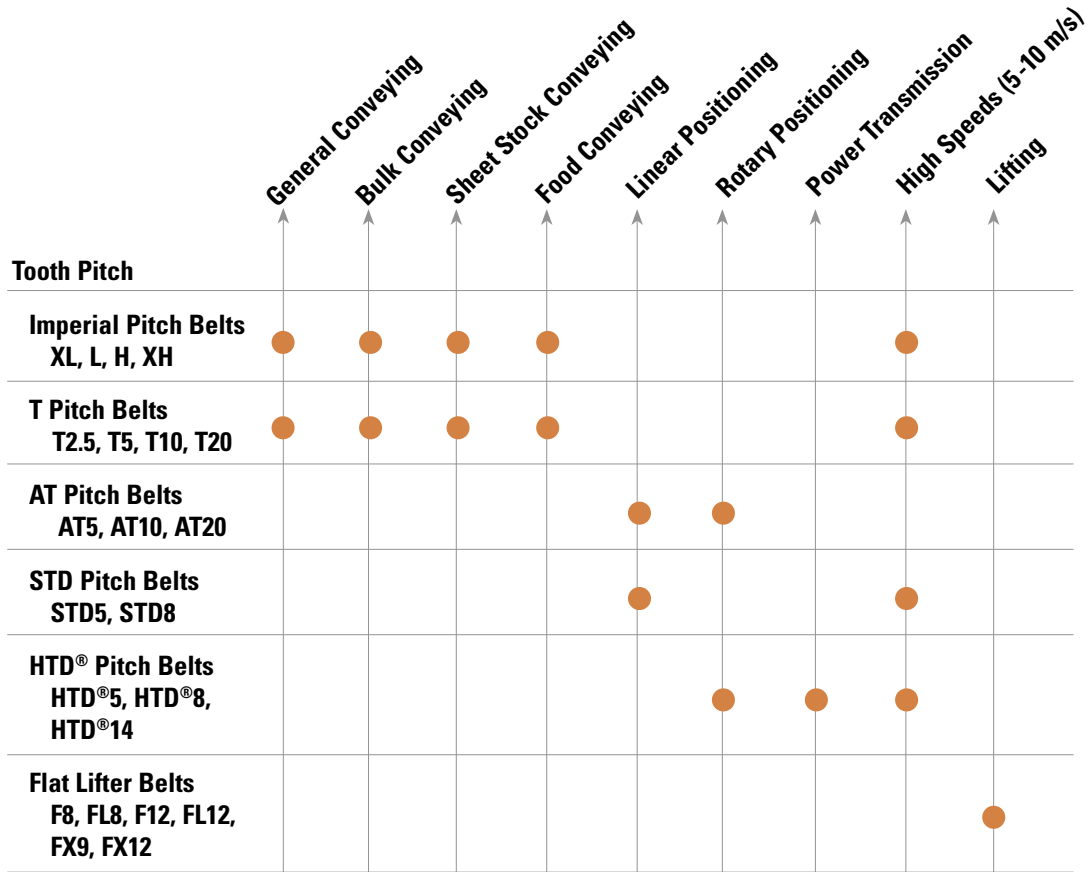

Tooth Pitch Comparison

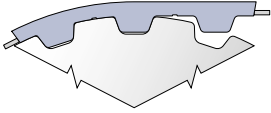

Imperial Pitch Belts - XL, L, H, XH

This classic trapezoidal pitch is the original timing belt tooth design. This tooth pitch is commonly used for **conveying applications**. The tooth profile is fairly low and has a large surface area at the tip of the tooth providing good support on sliding conveyor surfaces.

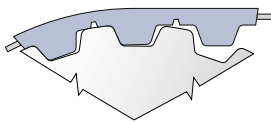

T Pitch Belts - T2.5, T5, T10, T20

These metric trapezoidal pitches are similar to imperial pitches, also commonly used for **conveying applications**, yet have a slightly deeper tooth engagement than imperial profiles. The tooth meshing is more reliable. However, backlash can be slightly greater.

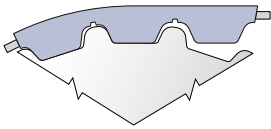

AT Pitch Belts - AT5, AT10, AT20

This pitch was developed to enable higher load carrying capacity combined with low backlash. The stronger and stiffer tooth makes these belts ideal for **linear positioning and motion control**, but may require larger pulley diameters.

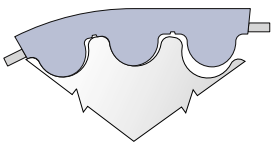

HTD[®] Pitch Belts - HTD[®]5, HTD[®]8, HTD[®]14

This rounded tooth pitch is similar to STD, and is also an excellent profile for **linear and rotary positioning and power transmission** applications, yet has deeper tooth engagement. Note that the HTD pitch may exhibit slight increases in noise and wear.

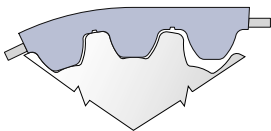

STD Pitch Belts - STD5, STD8

This tooth pitch provides superior load distribution, low backlash, and **reduced wear and noise** characteristics. It is an excellent profile for **linear positioning and power transmission** applications.

Linear Belt Overview

Linear timing belts provide the greatest degree of flexibility for synchronous conveying and linear positioning applications.

Gates Mectrol manufactures linear timing belts in a variety of tooth, pitch, length, and material combinations. This offering provides a wide range of possible configurations for your application.

Linear belt lengths are available in two styles — welded endless and open ended. Welded endless belts are ideal for low torque conveying applications. Open ended belts are typically used for motion control applications.

Features

- Very high tensile strength and stiffness
- Parallel cord construction
 - No cords exposed at belt edges
 - Better tracking
 - Uniform tensioning
- Tough polyurethane construction
 - Durable and cut resistant
 - Oil, chemical and water resistant
 - Non-marking
- Steel or Kevlar® tension members
- Choice of polymers including FDA grades
- Nylon® back and Nylon® tooth surface options available for quieter operation and reduced friction
- Various molded profiles and backing materials available
- Wide range of tooth pitches to meet your application requirements

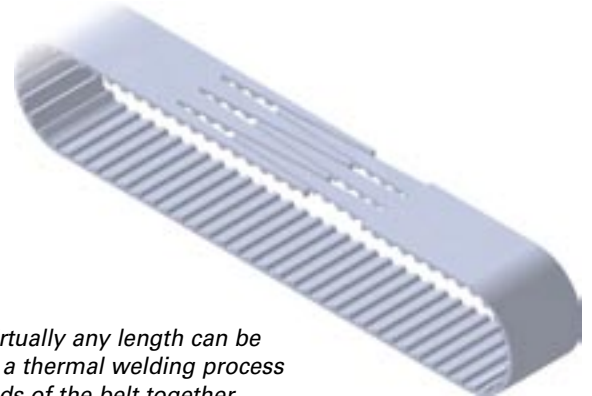

Endless belts of virtually any length can be produced utilizing a thermal welding process which joins the ends of the belt together.

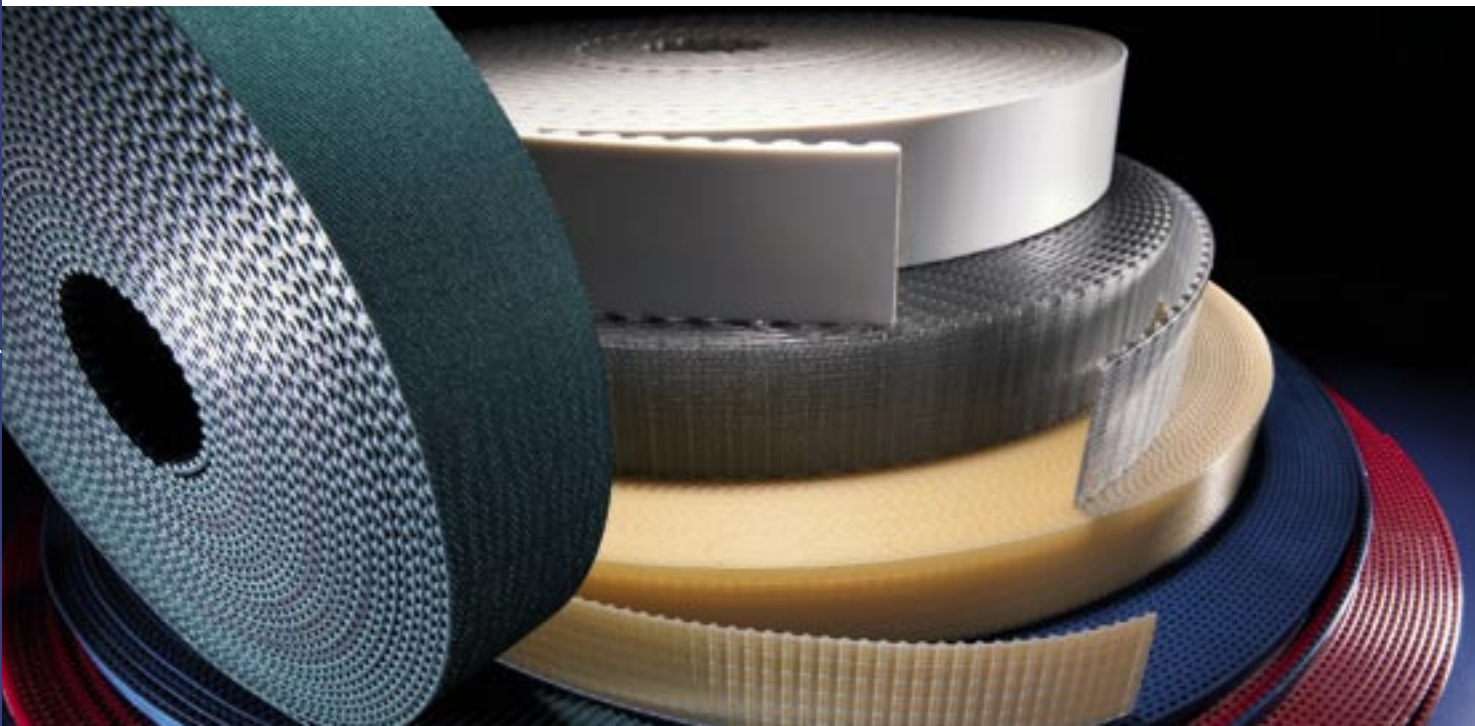

Linear Belt Applications

Application Characteristics

- High precision positioning or indexing
- Synchronous conveying
- High acceleration, deceleration or continuous high running speeds
- Multiple belt, common shaft conveying
- Customized belts to meet any application need

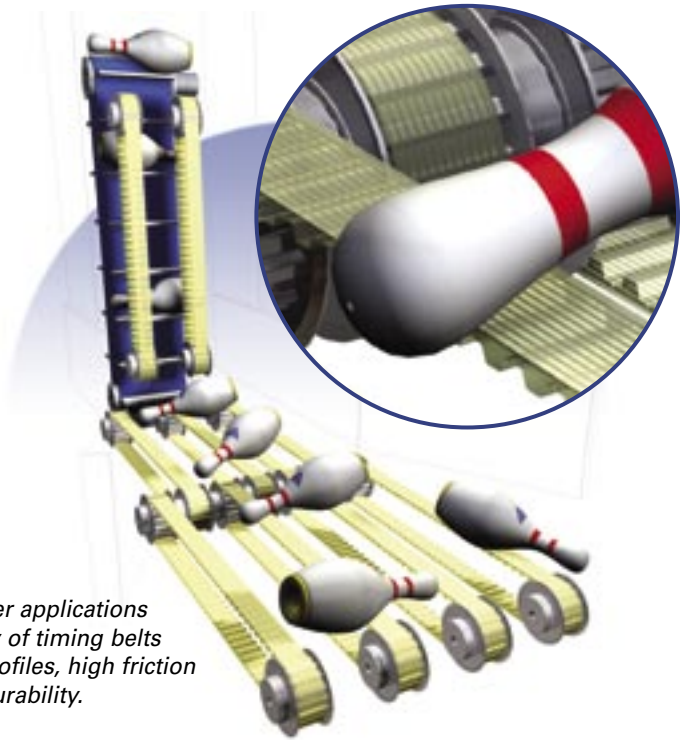

Bowling pinsetter applications require a variety of timing belts with different profiles, high friction backings, and durability.



Polyurethane timing belts are ideal for use in vertical and horizontal door applications. Durable and clean running, these belts provide quiet and positive motion for industrial, train, elevator, and automatic slide door applications.

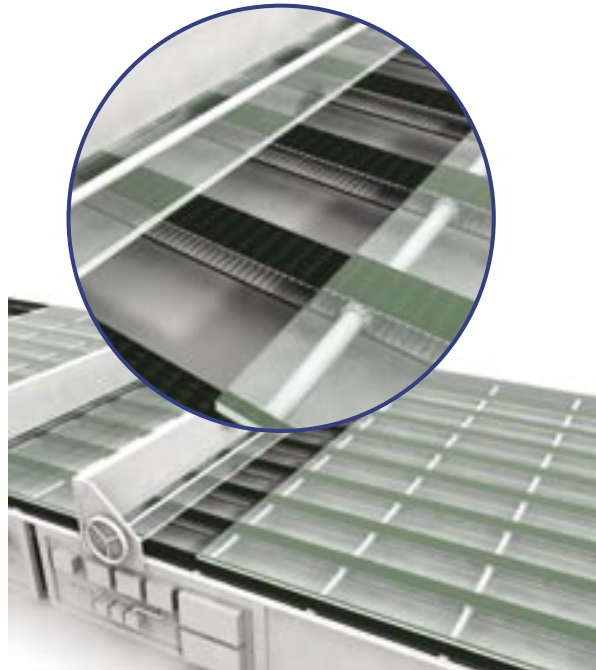

Rough Top backing on polyurethane timing belts allows synchronous conveying of sheet glass without interference from glass shards.

Linear Belt Specifications

			XL	L	H	H-HF	XH	T5	AT5	ATL5	
Pitch (Imperial and metric)			.200" 5,08 mm	.375" 9,525 mm	.500" 12,7 mm	.500" 12,7 mm	.875" 22,225 mm	5 mm	5 mm	5 mm	
Ultimate Tensile Strength per Inch or 25 mm Belt Width	Steel	lbf/in N/25 mm	730 3250	1330 5920	1570 6980	2380 10590	3160 14060	730 3250	1440 6410	2380 10590	
	Kevlar®	lbf/in N/25 mm	1360 6050	1710 7610	1820 8100	N/A N/A	3450 15350	1360 6050	1710 7610	N/A N/A	
Max. Allowable Belt Tension per Inch or 25 mm Belt Width	Steel and Kevlar®	Open Ended	lbf/in N/25 mm	180 800	330 1470	390 1730	590 2620	790 3510	180 800	360 1600	590 2620
		Welded	lbf/in N/25 mm	140 620	190 850	240 1070	240 1070	380 1690	140 620	210 930	N/A N/A
Allowable Effective Tension for the Belt Teeth (15 and More Teeth in Mesh)	Open Ended		lbf/in N/25 mm	180 800	360 1600	440 1960	440 1960	880 3910	200 890	290 1290	290 1290
	Welded		lbf/in N/25 mm	130 580	270 1200	330 1470	330 1470	660 2940	150 670	210 930	N/A N/A
Specific Belt Weight	Steel	lbf/ft/in kg/m/cm	0.036 0.021	0.059 0.035	0.066 0.039	0.072 0.042	0.180 0.105	0.037 0.022	0.055 0.032	0.062 0.036	
	Kevlar®	lbf/ft/in kg/m/cm	0.033 0.019	0.052 0.030	0.055 0.032	N/A N/A	0.155 0.091	0.033 0.020	0.046 0.027	N/A N/A	
Specific Belt Stiffness (Open Ended)	Steel	lbf/in N/mm	47950 8400	92800 16255	109000 19085	133600 23400	213600 37410	47950 8400	100500 17605	133600 23400	
	Kevlar®	lbf/in N/mm	52250 9155	69100 12100	60700 10635	N/A N/A	100000 17500	52250 9155	69100 12100	N/A N/A	
Min. No. of Pulley Teeth			10	10	14	12	18	10	15	15	
Min. Pitch Diameter			inch mm	.64" 16,25	1.19" 30,25	2.23" 56,65	1.91" 48,5	5.01" 127,25	16	24	24
Min. Diameter of Tensioning Idler Running on Back of Belt			inch mm	1.125 30	2.375 60	3.125 80	2.375 60	5.875 150	1.125 30	2.375 60	2.375 60
Available in FDA Compliant Construction (85 Shore A polyurethane)				Yes	Yes	Yes		Yes			
Standard Colors (C=Clear, W=White)				C	C	C	C	C	W	W	W

Service Temperature Range	-5°C to +70°C (23°F to 158°F)	
Hardness	92 Shore A - Standard PU, 85 Shore A - FDA Compliant PU	
Coefficient of Friction	Polyurethane vs. Steel (dry)	0.5 to 0.7
	Polyurethane vs. Aluminum (dry)	0.5 to 0.6
	Polyurethane vs. UHMWPE (dry)	0.2 to 0.4
	Nylon® vs. Steel (dry)	0.2 to 0.4
	Nylon® vs. UHMWPE (dry)	0.1 to 0.3

T10	T10-HF	AT10	ATL10	ATL10-HF	T20	AT20	ATL20	HTD®5	HTD®8	HTD®14	HTDL®14	STD5	STD8
10 mm	10 mm	10 mm	10 mm	10 mm	20 mm	20 mm	20 mm	5 mm	8 mm	14 mm	14 mm	5 mm	8 mm
1570 6980	2380 10590	3160 14060	5030 22380	5750 25580	3160 14060	5030 22380	7310 32520	2380 10590	3160 14060	4670 20770	7310 32520	2380 10590	3160 14060
1820 8100	N/A N/A	3450 15350	N/A N/A	N/A N/A	3450 15350	4410 19620	N/A N/A	2050 9120	3450 15350	4090 18190	N/A N/A	2050 9120	3450 15350
390 1730	590 2620	790 3510	1250 5560	1430 6360	790 3510	1100 4890	1820 8100	510 2270	790 3510	1020 4540	1820 8100	510 2270	790 3510
240 1070	240 1070	380 1690	N/A N/A	N/A N/A	380 1690	450 2000	N/A N/A	240 1070	380 1690	450 2000	N/A N/A	240 1070	380 1690
380 1690	380 1690	580 2580	580 2580	580 2580	710 3160	1220 5430	1220 5430	230 1020	420 1870	770 3430	770 3430	220 980	410 1820
280 1250	280 1250	430 1910	N/A N/A	N/A N/A	530 2360	910 4050	N/A N/A	160 710	270 1200	440 1960	N/A N/A	150 670	260 1160
0.074 0.043	0.079 0.046	0.096 0.056	0.114 0.067	0.118 0.069	0.125 0.073	0.169 0.099	0.185 0.108	0.070 0.041	0.101 0.059	0.182 0.107	0.210 0.123	0.067 0.039	0.087 0.051
0.062 0.036	N/A N/A	0.071 0.042	N/A N/A	N/A N/A	0.101 0.059	0.124 0.073	N/A N/A	0.050 0.029	0.080 0.047	0.143 0.084	N/A N/A	0.050 0.029	0.074 0.043
109000 19085	133600 23400	213600 37410	334600 58600	290000 50790	213600 37410	334600 58600	440000 77050	133600 23400	213600 37410	294400 51560	440000 77050	133600 23400	213600 37410
60700 10635	N/A N/A	100000 17500	N/A N/A	N/A N/A	100000 17500	100000 17500	N/A N/A	60700 10635	100000 17500	86500 15150	N/A N/A	60700 10635	100000 17500
14	12	15	25	20	15	18	30	14	20	28	43	14	20
45	38	48	80	64	96	115	191	22	51	125	191	22	51
3.125 80	2.375 60	4.750 120	5.875 150	5.125 130	4.750 120	7.125 180	9.875 250	2.375 60	4.750 120	7.875 200	9.875 250	2.375 60	4.750 120
Yes													
W	W	W	W	W	W	W	W	W	W	W	W	W	W

The specifications listed are based on Gates Mectrol's experience. However, our specifications and data do NOT cover all possible belt drive conditions. It is the responsibility of the belt drive system designer to ensure Gates Mectrol's belts are appropriate for a given system and application. The provided data is representative of our in-house experience and does not necessarily match product performance in industrial use. Gates Mectrol cannot assume any liability concerning the suitability and process ability of our products. We also cannot assume liability for process results, damages or consequential damages associated with the use of our products.

- HF designates high flex cords.
- Most belts are available with Nylon® fabric on either or both sides.
 For Nylon® on the tooth side, specify "NT"
 For Nylon® on the back side, specify "NB"
 For Nylon® on both sides, specify "NTB"
 Note: Nylon® on tooth side is NOT available on HTD®5 Steel or Kevlar® in widths greater than 50 mm.
- Belting produced to specific length tolerance is available upon request.
- Many linear positioning applications require belts of a specific length tolerance, or a "minus pitch tolerance."
 Gates Mectrol can produce belts to specific minus tolerances. Consult a Gates Mectrol Applications Engineer to determine the proper length tolerance calculation.

Imperial Pitch Belts

XL .200" Pitch

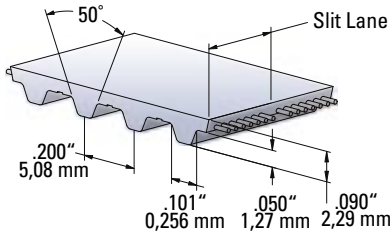

L .375" Pitch

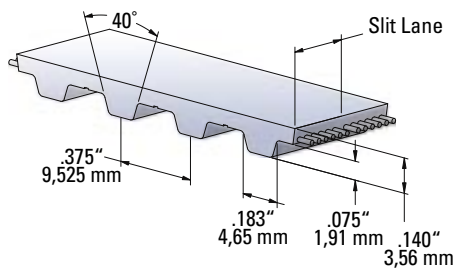

H, H-HF .500" Pitch

WH .500" Pitch—From 6" to 18" wide

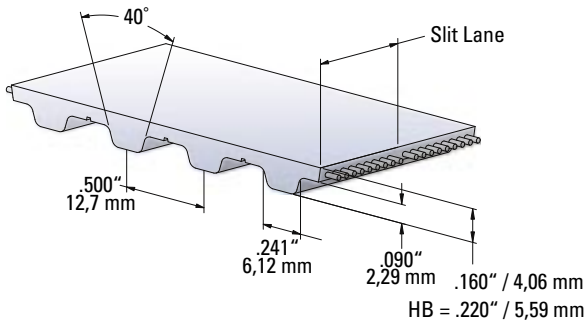

XH .875" Pitch

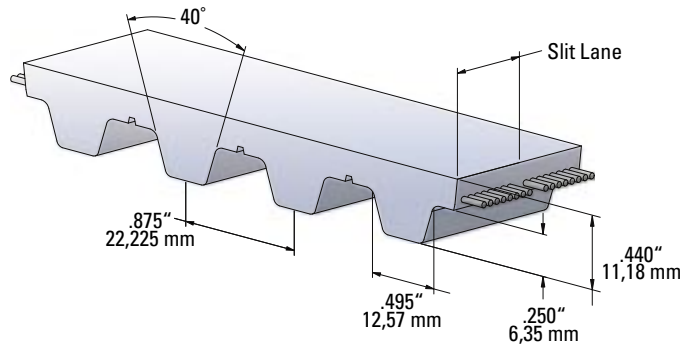

		XL	L	H*, H-HF*	XH
Min. Welded Belt Length	inch	17	17,25	17 (4" wide) 432	40,25
	mm	432	438	33,5 (6" wide) 851	1022
Standard Roll Lengths	feet	200	200	200	100
	meters	61	61	61	30
Standard Slitting Lanes	inch	1/4	1/2	1.0	1.0
	mm	6,35	12,7	25,4	25,4
Available Slitting Lanes	inch	N/A	N/A	3/4	N/A
	mm			19,05	

All roll lengths are ±1%.

*Heavy Back (HB) option available.

Available Widths

Code	inch	mm	XL	L	H, H-HF	XH
025	1/4	6.35	X			
031	5/16	7.94	X			
037	3/8	9.53	X	X	X	
050	1/2	12.7	X	X	X	X
075	3/4	19.05	X	X	X	X
100	1	25.4	X	X	X	X
150	1 1/2	38.1	X	X	X	X
200	2	50.8	X	X	X	X
300	3	76.2		X	X	X
400	4	101.6		X	X	X
600	6	152.4			X	X

All belts are available in any width between the minimum and maximum listed width.

Width Tolerances

Width	XL	L	H, H-HF	XH
Up to 2"	± .020"	± .020"	± .020"	± .040"
	0,5 mm	0,5 mm	0,5 mm	1 mm
> 2" - 4"	N/A	± .030"	± .030"	± .040"
		0,75 mm	0,75 mm	1 mm
> 4" - 6"	N/A	N/A	± .030"	± .040"
			0,75 mm	1 mm

To Order Imperial Pitch Belts

600	H	200	()	()	Insert "NT" for Nylon® Teeth, "NB" for Nylon® Back, "NTB" for Nylon® on Both Sides, "HB" for Heavy Backing, "FDA" for FDA
					Insert "K" if specifying Kevlar®
					Width: 2.0" x 100 = 200
					Pitch: H (1/2")
					Length: 60.0" x 10 = 600

T Pitch Belts

T5 5 mm Pitch

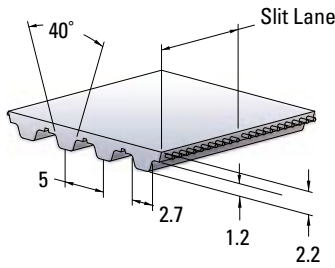

		T5	T10*, T10-HF*	T20
Min. Welded Belt Length	mm	440 (50 mm wide) 450 (100 mm wide)	450 (100 mm wide) 850 (150 mm wide)	1000
Standard Roll Lengths	meters	100	100	50
Standard Slitting Lanes	mm	25	25	25
Available Slitting Lanes	mm	10, 16	16, 32	N/A

All roll lengths are $\pm 1\%$.

*Heavy Back (HB) option available.

T10, T10-HF 10 mm Pitch

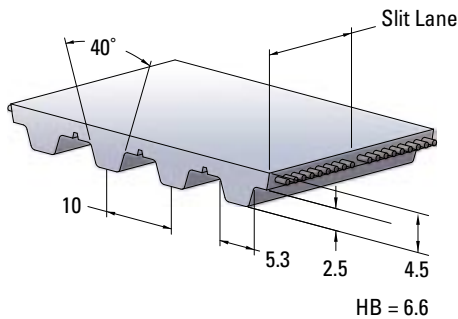

Available Widths

mm	T5	T10, T10-HF	T20
6	X		
10	X	X	
12	X	X	
16	X	X	
20	X	X	
25	X	X	X
32	X	X	X
50	X	X	X
75	X	X	X
100	X	X	X
150		X	X

All belts are available in any width between the minimum and maximum listed width.

T20 20 mm Pitch

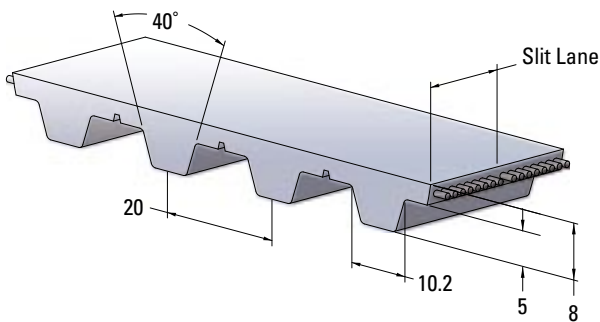

Width Tolerances

Width	T5	T10, T10-HF	T20
Up to 50 mm	± 0.5 mm	± 0.5 mm	± 1.0 mm
> 50-100 mm	± 0.75 mm	± 0.75 mm	± 1.0 mm
> 100-150 mm	N/A	± 0.75 mm	± 1.0 mm

To Order T Pitch Belts

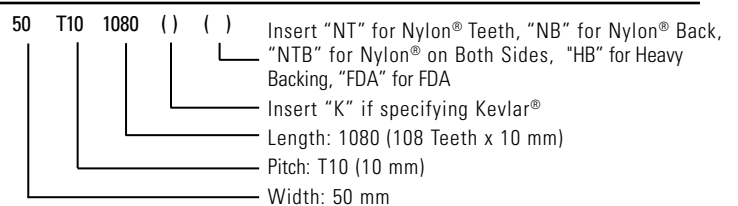

AT Pitch Belts

AT5 and ATL5 5 mm Pitch

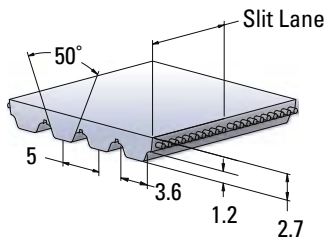

		AT5	ATL5	AT10	ATL10, ATL10-HF	AT20, ATL20
Min. Welded Belt Length	mm	440	N/A	460 (100 mm wide) 860 (150 mm wide)	N/A	1000
Standard Roll Lengths	meters	100	100	100	100	50
Standard Slitting Lanes	mm	25	25	25	25	N/A
Available Slitting Lanes	mm	10, 16	16	N/A	N/A	N/A

All roll lengths are ±1%.

AT10, ATL10, and ATL10-HF 10 mm Pitch

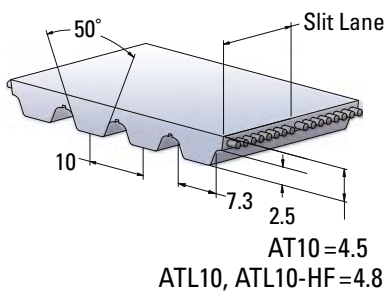

Available Widths

mm	AT5	ATL5	AT10, ATL10, ATL10-HF	AT20, ATL20
6	X			
10	X	X		
12	X	X		
16	X	X	X	
20	X	X	X	
25	X	X	X	X
32	X	X	X	X
50	X	X	X	X
75	X	X	X	X
100	X	X	X	X
150		X	X	X

All belts are available in any width between the minimum and maximum listed width.

AT20 and ATL20 20 mm Pitch

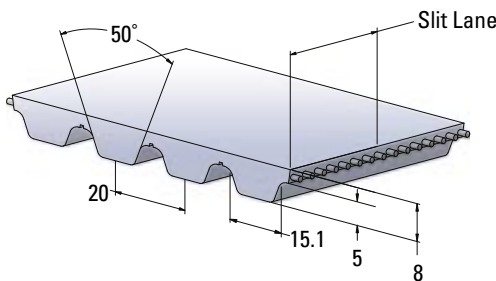

Width Tolerances

Width	AT5	ATL5	AT10	ATL10, ATL10-HF	AT20	ATL20
Up to 50 mm	±0.5 mm	±0.5 mm	±0.75 mm	± 1.0 mm	± 1.0 mm	± 2.0 mm
> 50-100 mm	±0.75 mm	±0.75 mm	± 1.0 mm	±1.5 mm	± 1.5 mm	± 2.0 mm
> 100-150 mm	N/A	±0.75 mm	± 1.0 mm	± 1.5 mm	± 1.5 mm	± 2.0 mm

To Order AT Pitch Belts

50 AT10 1080 () ()

- Insert "NT" for Nylon® Teeth, "NB" for Nylon® Back, "NTB" for Nylon® on Both Sides
- Insert "K" if specifying Kevlar®
- Length: 1080 (108 Teeth x 10 mm)
- Pitch: AT10 (10 mm)
- Width: 50 mm

HTD® and STD Pitch Belts

HTD®5 5 mm Pitch

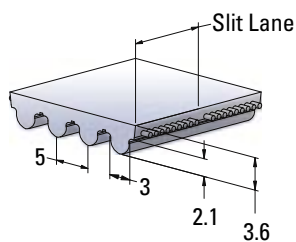

HTD®8 8 mm Pitch

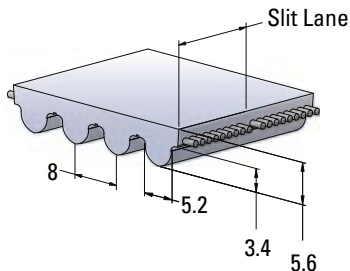

HTD®14, HTDL®14 14 mm Pitch

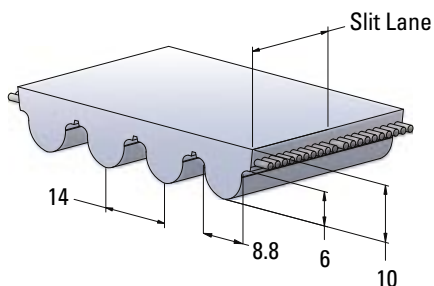

STD5 5 mm Pitch

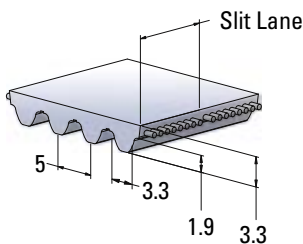

STD8 8 mm Pitch

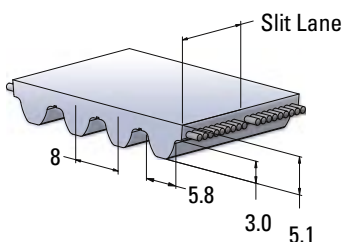

		HTD®5	HTD®8	HTD®14, HTDL®14	STD5	STD8
Min. Welded Belt Length	mm	450	456	1000	450	456
Standard Roll Lengths	meters	100	100	50	100	100
Standard Slitting Lanes	mm	25	20, 30	55	25	20, 30
Available Slitting Lanes	mm	N/A	25	85	10	25

All roll lengths are ±1%.

Available Widths

mm	HTD®5	HTD®8	HTD®14, HTDL®14	STD5	STD8
5	X			X	
10	X	X		X	X
15	X	X		X	X
20		X			X
25	X	X	X	X	X
30		X			X
40			X		
50	X	X		X	X
55			X		
85	X*	X	X		X
100	X*	X	X		X
115			X		
150	X*	X**			
170			X		

All belts are available in any width between the minimum and maximum listed width.

* These widths are only available in HTD®5 Steel or HTD®5 Steel with NB.

** This width is not available in HTD8 Kevlar®.

Width Tolerances

Width	HTD®5	HTD®8	HTD®14, HTDL®14	STD5	STD8
Up to 50 mm	±0.5 mm	±0.75 mm	±1.0 mm	±0.5 mm	±0.75 mm
> 50-100 mm	±0.75 mm	±1.0 mm	±1.5 mm	N/A	±1.0 mm
> 100-150 mm	±0.75 mm	±1.0 mm	±2.0 mm	N/A	N/A
> 150-170 mm	N/A	N/A	±2.0 mm	N/A	N/A

To Order HTD® and STD Pitch Belts

25 HTD®5M 1000 () ()

Insert "NT" for Nylon® Teeth, "NB" for Nylon® Back, "NTB" for Nylon® on Both Sides

Insert "K" if specifying Kevlar®

Length: 1000 mm

Pitch: HTD®5 (5 mm)

Width: 25 mm

Self Tracking Belts

Notched V-Guide – Allows Maximum Flexibility

Gates Mectrol self tracking timing belts have all the capabilities of standard polyurethane timing belts but utilize guides to eliminate any lateral movement. Our range of specially designed polyurethane V-guides are notched along the belt length to provide optimum flexibility around pulleys.

Gates Mectrol manufactures V-guided belts in two constructions — **fabricated**, any of four V-guides can be added to any pitch belt in any width, length combination, or — **integral**, the V-guide is integrally molded to specific belt pitches for greater strength and consistency.

Features

- V-guides can be added to virtually any of our belts, eliminating the need for flanged pulleys
- Notched construction for extra flexibility around tight belt paths
- Produced with the same durable polyurethane as the base belt
- Different sizes available to serve any application requirement
- Integrally produced with the belt for durability or fabricated to fit onto our existing belts

Fabricated V-Guides

For Metric Tooth Pitch Belts

K6 Section

K13 Section

For Imperial Tooth Pitch Belts

A Section

O Section

Belt Dimensions

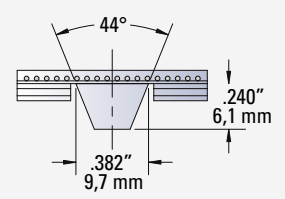
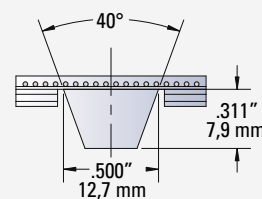
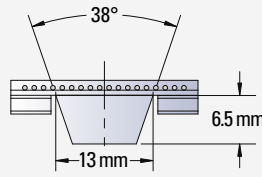
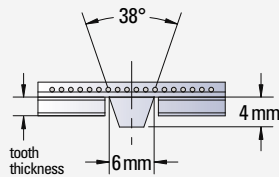

Pulley Dimensions

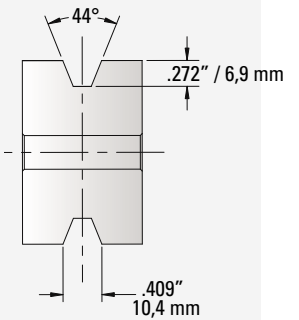
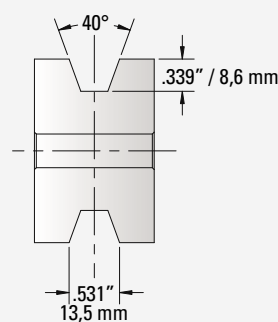
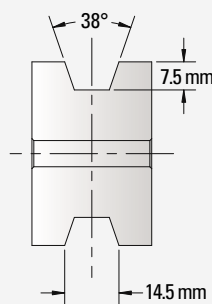
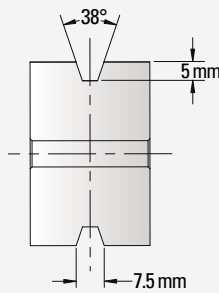

Slider Bed Dimensions

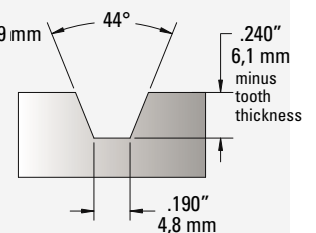
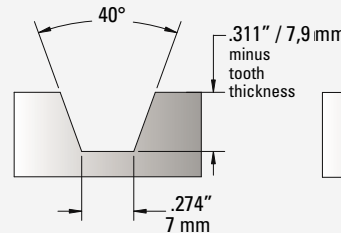
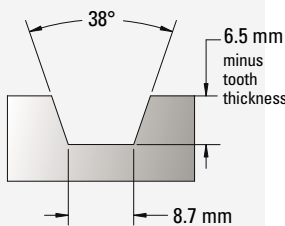
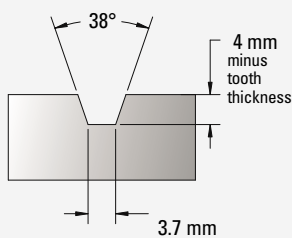

Application Characteristics

- Long length conveying or linear positioning where tracking is an issue
- Conveying applications where design considerations prevent the use of pulley flanges
- Reduce or eliminate any belt "wander" by providing continuous guiding along conveyor length

Integral V-Guides

		T5V	T10VS	T10V	AT5V	ATL5V	AT10V	HV
Min. Welded Belt Length	inch							36
	mm	920	900	900	900	N/A	950	914
Standard Roll Length	feet							200
	meters	100	100	100	100	100	100	61
Standard Slitting Lanes	inch							1
	mm	25	25	25	25	25	25	25,4

All roll lengths are ±1%.

Width Tolerances

Width	T5V	T10VS	T10V	AT5V	ATL5V	AT10V	HV
Up to 50 mm Up to 2"	±0.5 mm	± 0.5 mm	± 0.5 mm	± 0.5 mm	± 0.5 mm	± 0.75 mm	± 0.020 in ± 0.5 mm
>50 - 100 mm >2" - 4"	±0.75 mm	N/A	±0.75 mm	N/A	N/A	± 1.0 mm	± 0.030 in ± 0.75 mm
>100 mm to 150 mm >4" - 6"	N/A	N/A	± 0.75 mm	N/A	N/A	±1.0 mm	±0.030 in ±0.75 mm

T5V (K6 Section)

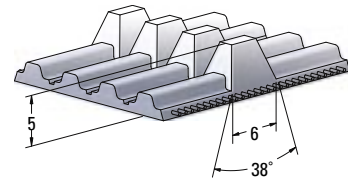

Available widths
– 16, 25, 32, 50, 75, 100 mm

AT5V, ATL5V (K6 Section)

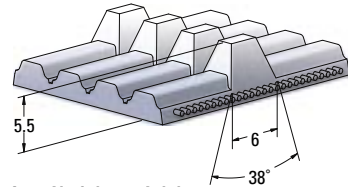

Available widths
– 16, 25, 32, 50 mm

T10VS (K6 Section)

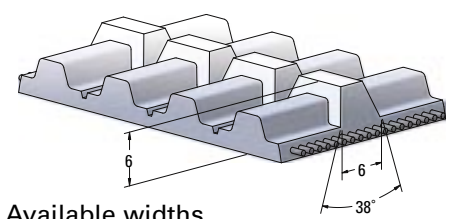

Available widths
– 16, 25, 32, 50 mm

T10V (K13 Section)

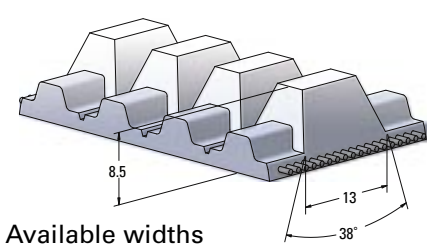

Available widths
– 32, 50, 75, 100, 150 mm

AT10V (K13 Section)

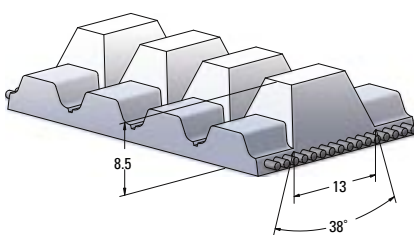

Available widths
– 25, 32, 50, 75 mm

HV (A Section)

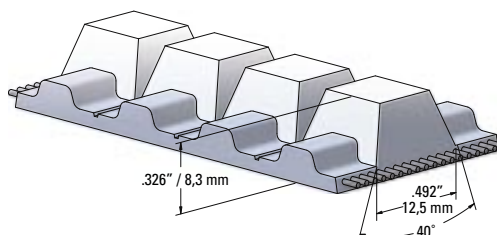

Available widths
– 1.5, 2, 3, 4, 6 inch

Wide Belt Overview

Gates Mectrol can produce polyurethane timing belts in widths up to 450 mm. These belts are specifically designed for synchronous conveying applications.

Wide belts are primarily used as process conveyor belts. Process (or conversion steps) normally occur on the belt, therefore the conveyed product requires additional width.

Features

- High strength Kevlar® cord construction
- Parallel cord construction
 - No cords exposed at edges of belt
 - Better tracking
 - Uniform tensioning
- Tough polyurethane construction
 - Durable and cut resistant
 - Oil, chemical and water resistant
 - Non-marking
- Choice of polymers including FDA grades
- Nylon® back and Nylon® tooth surface options available for quieter operation and reduced friction
- Various molded profiles and backing materials available
- No lubrication required



In deboning applications, FDA approved polyurethane timing belts provide zero slip conveying, easy wash down and clean up while being very resistant to knife cuts.

Wide Belt Applications

Application Characteristics

- Replaces flat conveyor belt
 - No retensioning required
 - Lower shaft forces
 - Positive indexing
 - Higher acceleration without slippage
- Alternative to modular plastic conveyor
 - Quieter operation
 - Easier cleaning
 - No hinges or pins to break and contaminate products
- High speed conveying
- Rapid indexing
- Automated process conveyor belts
- Bulk product conveying
- Food and confectionery conveying
- Clean room or wash down environments
 - Consult Applications Engineering staff for restrictions



Four 450 mm wide, timing belts accelerate skiers for faster loading of detachable chair lifts. Timing belts ensure uniform speed of each skier.

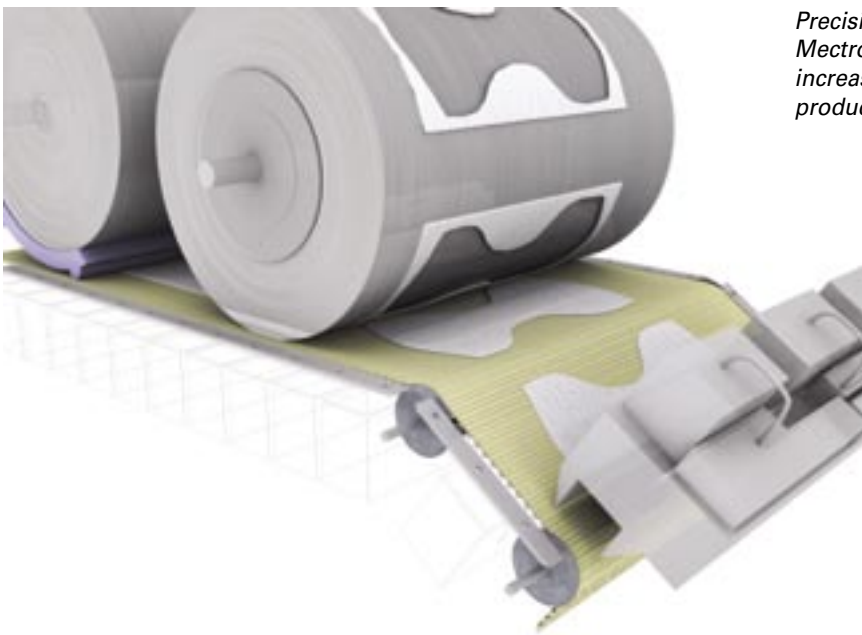

Precision high speed indexing with Gates Mectrol extra wide timing belts dramatically increases throughput and yields on diaper production lines.

Wide Belt Specifications

			WH	WT10
Pitch (Imperial and metric)			.500" 12,7 mm	10 mm
Ultimate Tensile Strength per Inch or 25 mm Belt Width	Kevlar®	lbf/in N/25 mm	760 3380	760 3380
Max. Allowable Belt Tension per Inch or 25 mm Belt Width	Welded	lbf/in N/25 mm	100 440	100 440
Allowable Effective Tension for the Belt Teeth (15 and More Teeth in Mesh)	Welded	lbf/in N/25 mm	330 1470	280 1250
Specific Belt Weight	Kevlar®	lbf/ft/in kg/m/cm	0.056 0.033	0.066 0.039
Specific Belt Stiffness (Open Ended)	Kevlar®	lbf/in N/mm	30350 5300	30350 5300
Min. No. of Pulley Teeth			14	16
Min. Pitch Diameter		inch mm	2.23 56,64	51
Min. Diameter of Tensioning Idler Running on Back of Belt		inch mm	3.12 80	3.12 80
Available in FDA Compliant Construction (85 Shore A polyurethane)			Yes	Yes
Standard Colors (C=Clear)			C	C
Min. Welded Belt Length		inch mm	33 838	850
Standard Roll Length		ft m	200 61	60
Standard Slitting Lanes			N/A	N/A
Min. Width Available		inch mm	6 152,4	150
Max. Width Available		inch mm	18 457,2	450
Width Tolerance		inch mm	± .060 ± 1.52	± 1.0

Service Temperature Range	-5°C to +70°C (23°F to 158°F)	
Hardness	92 Shore A - Standard PU, 85 Shore A - FDA Compliant PU	
Coefficient of Friction	Polyurethane vs. Steel (dry)	0.5 to 0.7
	Polyurethane vs. Aluminum (dry)	0.5 to 0.6
	Polyurethane vs. UHMWPE (dry)	0.2 to 0.4
	Nylon® vs. Steel (dry)	0.2 to 0.4
	Nylon® vs. UHMWPE (dry)	0.1 to 0.3

The specifications listed are based on Gates Mectrol's experience. However, our specifications and data do NOT cover all possible belt drive conditions. It is the responsibility of the belt drive system designer to ensure Gates Mectrol's belts are appropriate for a given system and application. The provided data is representative of our in-house experience and does not necessarily match product performance in industrial use. Gates Mectrol cannot assume any liability concerning the suitability and process ability of our products. We also cannot assume liability for process results, damages or consequential damages associated with the use of our products.

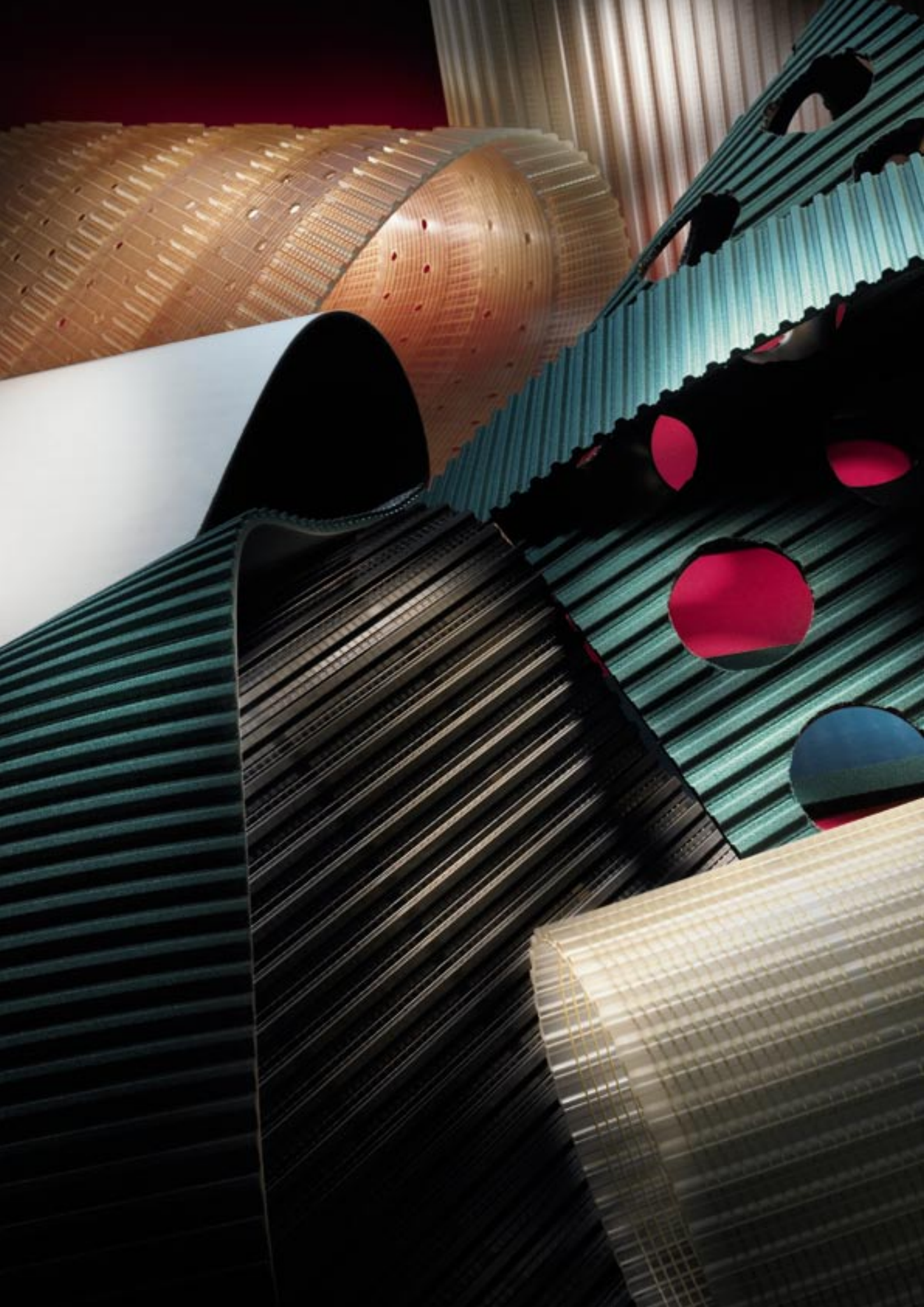

Flat Belt Overview

Gates Mectrol offers a full line of high strength, low stretch flat belts for lifting and positioning applications. These flat belts are typically sold in open ended lengths and are clamped at each end.

Application Characteristics

- Heavy load lifting or lowering
- Allows for "slip" requirement
- Smooth uniform motion
- Small bending radius for small design envelope
- Very low stretch characteristics

Features

- Smooth, vibration free operation
- Use with small pulley diameters
- High strength, low stretch for long life
- Sealed edges, no cord fraying
- Easily guided with flanged pulleys
- Kevlar® or steel cord construction
- No lubrication needed
- No retensioning required

Gates Mectrol's Kevlar® reinforced polyurethane flat belts are oil and cut resistant, making them ideal for harsh environments such as metal stamping conveyors.

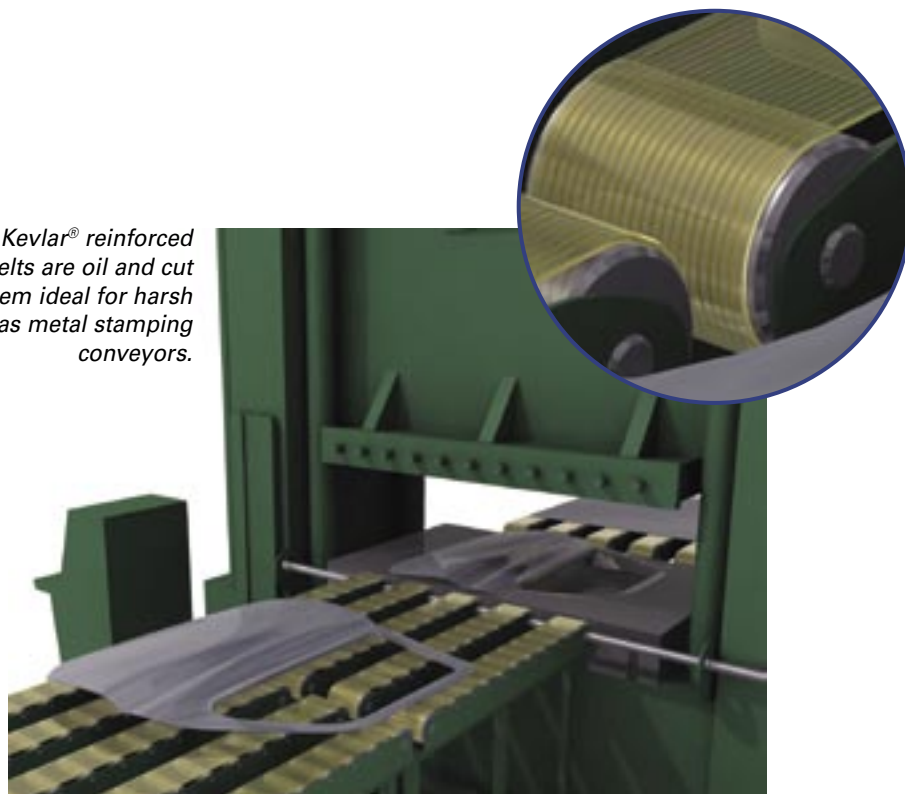

Flat Belts

		F8, F8U	FL8	F12, F12U	FL12	FX9, FX12
Min. Welded Belt Length	inch	19	N/A	20	N/A	N/A
	mm	483	N/A	508	N/A	N/A
Standard Roll Lengths	feet	200	200	200	200	200
	meters	61	61	61	61	61
Standard Slitting Lanes	inch	1	1	1	1	1
	mm	25	25	25	25	25

All roll lengths are $\pm 1\%$.

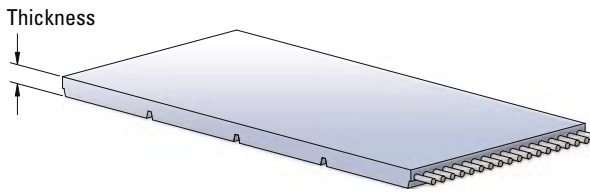

Available Widths

Code	Inch	mm	F8, FL8, F12, FL12, F8U, F12U	FX9, FX12
025	1/4	6.35		
050	1/2	12.7	X	
075	3/4	19.05	X	X
100	1	25.4	X	X
150	1 1/2	38.1	X	X
200	2	50.8	X	X
300	3	76.2	X	X
400	4	101.6	X	X

All belts are available in any width between the minimum and maximum listed width.

	Nominal Thickness
F8	0.080" 2 mm
FL8	0.080" 2 mm
F12	0.125" 2 mm
FL12	0.125" 3,2 mm
FX9	0.090" 2,3 mm
FX12	0.120" 3 mm

Width Tolerances

Width	F8, FL8, F12, FL12, F8U, F12U	FX9, FX12
Up to 2" < 50 mm	$\pm .020"$ $\pm 0,5$ mm	$\pm .030"$ $\pm 0,75$ mm
> 2" - 4" 50-100 mm	$\pm .030"$ $\pm 0,75$ mm	$\pm .030"$ $\pm 0,75$ mm

Flat Belt Specifications

			F8	FL8	F12	FL12	FX9	FX12	
Nominal Thickness	inch mm		.080 2.0	.080 2.0	.125 3.0	.125 3.0	.090 2.3	.120 3.0	
Ultimate Tensile Strength per Inch or 25 mm Belt Width	Steel	lbf/in N/25 mm	1570 6980	3160 14060	1570 6980	5030 22380	N/A N/A	N/A N/A	
	Kevlar®	lbf/in N/25 mm	1820 8100	N/A N/A	2050 9120	N/A N/A	4090 18190	4680 20820	
Max. Allowable Belt Tension per Inch or 25 mm Belt Width	Steel and Kevlar®	Open Ended	lbf/in N/25 mm	390 1730	790 3510	390 1730	1250 5560	1020 4540	1170 5200
		Welded	lbf/in N/25 mm	240 1070	N/A N/A	240 1070	N/A N/A	N/A N/A	N/A N/A
Specific Belt Weight	Steel	lbf/ft/in kg/m/cm	.057 .033	.073 .043	.078 .046	.113 .066	N/A N/A	N/A N/A	
		Kevlar®	lbf/ft/in kg/m/cm	.045 .026	N/A N/A	.066 .039	N/A N/A	.043 .025	.060 .035
Specific Belt Stiffness (Open Ended)	Steel	lbf/in N/mm	109000 19085	213600 37410	109000 19085	334600 58600	N/A N/A	N/A N/A	
		Kevlar®	lbf/in N/mm	60700 10635	N/A N/A	60700 10635	N/A N/A	90000 15760	130000 22760
Min. Pulley Diameter	inch mm		2.0 50	2.375 60	2.0 50	3.0 75	3.0 75	4.0 100	
Min. Diameter of Tensioning Idler Running on Back of Belt	inch mm		3.0 80	4.75 120	3.0 80	4.75 120	4.5 115	6.0 150	
Standard Material			PU	PU	PU	PU	PU or TPR	PU or TPR	
Standard Colors (C=Clear, BK=Black)			C	BK	C	BK	BK	BK	

Do not use Gates Mectrol belts in applications that depend solely upon the belt to raise/lower, support or sustain a mass without an independent safety backup system. The specifications listed are based on Gates Mectrol's experience. However, our specifications and data do NOT cover all possible belt drive conditions. It is the responsibility of the belt drive system designer to ensure Gates Mectrol's belts are appropriate for a given system and application. The provided data is representative of our in-house experience and does not necessarily match product performance in industrial use. Gates Mectrol cannot assume any liability concerning the suitability and process ability of our products. We also cannot assume liability for process results, damages or consequential damages associated with the use of our products.

To Order Flat Belts

600 F12 200 () ()

Insert "NB" for Nylon® Back,
 "NT" for Nylon® Tooth (flight side), "NTB" for Nylon® on Both Sides.
 "FDA" for FDA
 Insert "K" if specifying Kevlar®
 Width: 2.0" x 100 = 200
 Belt Type: F12
 Length: 60.0" x 10 = 600

Flat Belt – Design Recommendations

- In contrast to typical flat belts, Gates Mectrol flat belts have very high strength and extremely low stretch. They are designed to be run on flat faced pulleys with flanges. Crowned pulleys should not be used.
- Gates Mectrol flat belts are not recommended for applications which involve belt twisting. Should an application require that a belt be twisted 90°, the length over which the twist occurs should be a minimum of 15 inches / 380 mm per 1 inch / 25 mm width of belt.
- Gates Mectrol flat belts are not to be used in lat pull down machines or other machines in which belt twist is unrestricted.

Materials		92A PU	85A PU	TPR
Service Temperature Range		-5°C to 70°C (23°F to 158°F)	-10°C to 60°C (19°F to 140°F)	-10°C to 70°C (19°F to 158°F)
Hardness, Shore A		92	85	90
Coefficient of Friction	Belt Material vs. Steel (dry)	0.5	0.7	0.5
	Polyurethane vs. Aluminum (dry)	0.5	0.6	0.5
	Belt Material vs. UHMWPE (dry)	0.2	0.4	0.2
	Nylon® vs. Steel (dry)	0.2 to 0.4	0.2 to 0.4	0.2 to 0.4
	Nylon® vs. UHMWPE (dry)	0.1 to 0.3	0.1 to 0.3	0.1 to 0.3



Precision high strength, low stretch flat belts utilize tough polyurethane construction with specialty high carbon steel cord to lift heavy loads such as elevators.

Profiled Belts Overview

Gates Mectrol timing belts can be customized with welded-on profiles to meet your application's specific holding, pushing, lifting, or actuating requirements. These profiles can be molded into almost any shape making profiled belts ideal for your assembly, packaging, inserting and other automation equipment requirements.

Our molded profiles are produced in polyurethane and become an integral part of the belt through thermal bonding.

Application Characteristics

- Pushing, carrying or actuating in packaging applications
- Product location in process applications
- Holders for mounting devices
- Interchangeable spacing for alternate product conveying

Features

- Non-marking, durable designs
- Molded and located on the belt to exacting tolerances
- Can be molded to virtually any custom configuration
- Thermally fused to base belt material
- Available with metal inserts, including threaded inserts

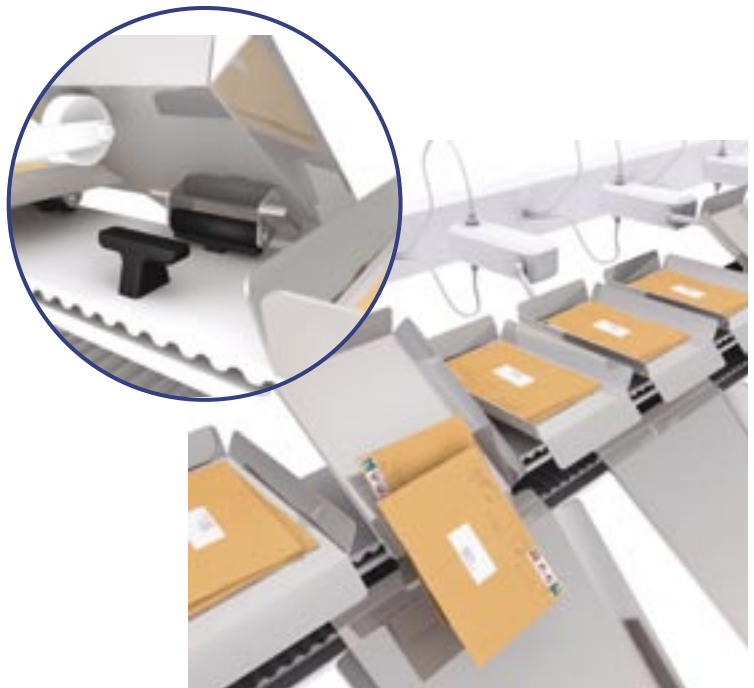

Custom profiles are used for pins and rests on a tilt-tray mail sorting machine.

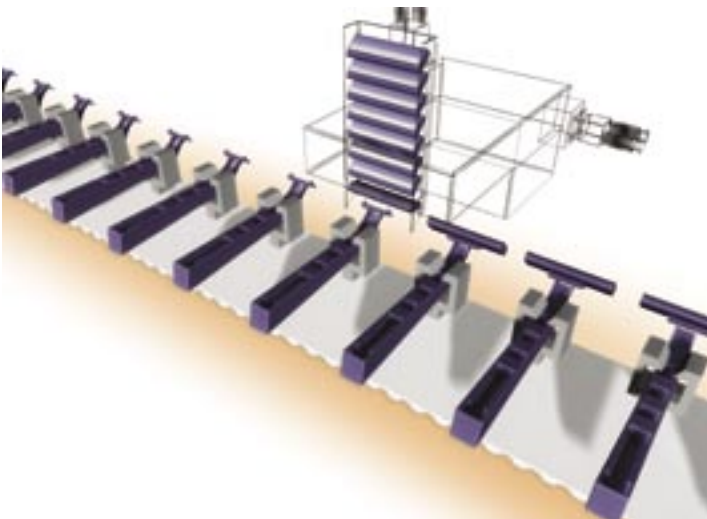

Exact placement of the profile allows for precision assembly of parts. In this application, razor heads are mounted accurately as a result of the Gates Mectrol profiled timing belt.

Profiled Belts – Design Recommendations

Over one thousand profile designs are available from Gates Mectrol’s extensive mold inventory. Our applications engineers can work with you to design any profile to meet your specific requirements. Tooling charges are minimal for most customized designs.

Although it is possible to have nearly any design utilizing welded profiles, ultimate performance for your application can be achieved by following the design guidelines outlined below:

1. Profile Spacing

It is recommended that the profile spacing, A, correspond with the pitch of the belt teeth. This allows for the best spacing tolerances, and minimizes the effects of the belt’s overall length tolerance on the profile spacing.

Profiles can be spaced on non-pitch increments. However, if non-pitch spacing is used, the cumulative tolerance of the belt length must be considered.

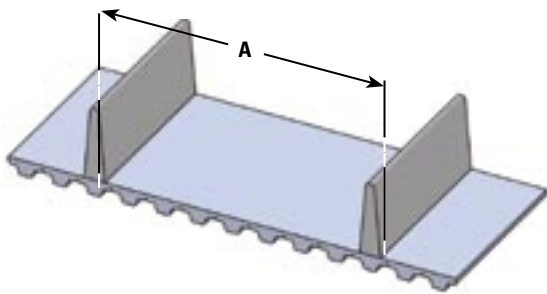

Profile Spacing Tolerance

Profile Spacing	Over Tooth Non-cumulative	Not Over Tooth
0.2" ≤ A < 1.0" 5 mm ≤ A < 25.4 mm	±0.015" ±0.38 mm	±0.020" ±0.5 mm
1.0" ≤ A < 9.0" 25.4 mm ≤ A < 228.6 mm	±0.020" ±0.5 mm	±0.025" ±0.6 mm
9.0" ≤ A < 18.0" 228.6 mm ≤ A < 457.2 mm	±0.025" ±0.6 mm	±0.030" ±0.8 mm
18.0" ≤ A < 27.0" 457.2 mm ≤ A < 685.8 mm	±0.030" ±0.8 mm	±0.035" ±0.9 mm
27.0" ≤ A < 36.0" 685.8 mm ≤ A < 914.4 mm	±0.035" ±0.9 mm	±0.040" ±1.0 mm

For spacing greater than 36.0", add 0.006" per ft.

For spacing greater than 914.4 mm, add 0.15 mm per 305 mm.

Tighter tolerances on profile spacing are available. Contact a Gates Mectrol Applications Engineer for more information.

2. Profile Dimensions

The most important considerations while dimensioning a profile are the size of the base of the profile ("foot" of the profile) and the position of the profile on the belt.

The profile thickness can affect the flexibility of the belt, and can determine the minimum allowable pulley diameter. The flexibility of the belt can be maximized, however, by positioning the profile directly over the tooth of the belt.

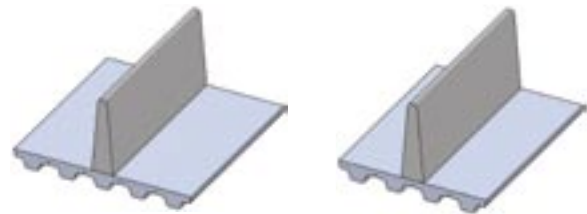

Over Tooth

Not Over Tooth

As the thickness of the foot of the profile increases, the minimum pulley diameter in the system must be increased according to the table on the next page.

The molded tolerances of the profile itself i.e. thickness, height, length, etc. are controlled within ±.010"/±0,25 mm. The installed height tolerance of a profile is typically +.010"/-.020"/+ 0,25 mm, - 0,5 mm.

Gates Mectrol Applications Engineers will assist in all regards where tolerances are an issue.

Profiled Belts – Design Recommendations

Minimum Number of Pulley Teeth For Profiles Over a Tooth*

Profile "Foot" Thickness	Inch mm	1/16 1.60	1/8 3.00	3/16 5.00	1/4 6.00	5/16 8.00	3/8 10.00	7/16 11.00	1/2 13.00	5/8 16.00	3/4 19.00
XL		10	10	18	25	40	50	60	100	N/R	N/R
L		12	12	12	18	30	40	50	60	100	N/R
H, H-HF		14	14	14	14	18	25	35	45	80	100
XH		18	18	18	18	18	18	18	20	35	50
T5		12	12	18	25	40	50	60	100	N/R	N/R
AT5, ATL5		15	15	18	25	40	50	60	100	N/R	N/R
T10, T10-HF		16	16	16	16	18	25	35	45	80	100
AT10		18	18	18	18	22	25	35	45	80	100
ATL10, ATL10-HF		25	25	25	25	25	25	35	45	80	100
T20, AT20		18	18	18	18	18	18	18	20	35	50
ATL20		30	30	30	30	30	30	30	30	35	50
HTD®5, STD5		14	14	16	25	40	50	60	100	N/R	N/R
HTD®8, STD8		20	20	20	24	30	40	50	60	100	N/R
HTD®14		28	28	28	28	28	28	30	30	50	72
HTDL®14		43	43	43	43	43	43	43	43	50	72

Minimum Number of Pulley Teeth For Profiles Not Over a Tooth*

Profile "Foot" Thickness	Inch mm	1/16 1.60	1/8 3.00	3/16 5.00	1/4 6.00	5/16 8.00	3/8 10.00	7/16 11.00	1/2 13.00	5/8 16.00	3/4 19.00
XL		12	30	45	50	60	100	N/R	N/R	N/R	N/R
L		12	20	40	45	55	60	70	80	100	N/R
H, H-HF		14	14	25	30	45	50	55	65	80	100
XH		18	18	20	30	40	45	50	54	58	60
T5		12	30	45	50	60	100	N/R	N/R	N/R	N/R
AT5, ATL5		15	30	45	50	60	100	N/R	N/R	N/R	N/R
T10, T10-HF, AT10		18	20	30	40	45	50	55	65	80	100
ATL10, ATL10-HF		25	25	30	40	45	50	55	65	80	100
T20, AT20		18	18	20	30	40	45	50	54	58	60
ATL20		30	30	30	30	40	45	50	54	58	60
HTD®5, STD5		18	30	45	50	60	100	N/R	N/R	N/R	N/R
HTD®8, STD8		20	20	40	45	55	60	70	80	100	N/R
HTD®14		28	28	30	42	58	64	72	78	82	86
HTDL®14		43	43	43	43	58	64	72	78	82	86

*Minimum number of pulley teeth must be equal to or greater than minimum shown in the appropriate Belt Specifications Table.

N/R = not recommended

3. Profile Strength

The strength, and therefore capacity of the profile, depends primarily on the size of the welded profile foot.

The strength of the profile is affected by the type and direction of the force applied to it. Under high loads, the failure mode will normally be either bending and distortion of the profile and belt, or in some cases, the polyurethane may actually tear.

With a load introduced against the profile at a point 1/4" / 6,35 mm above the belt surface, the strength of the profile is 2,500 lbs. per square inch of welded foot area, or 17,24 N/mm².

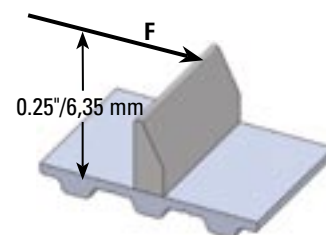

Profiled Belts – Design Recommendations

4. Wide Base Profiles, and Profiles With Relief

For profiles requiring a wide base, such as pushers, one foot should be left unwelded. This allows for flexing around the pulley yet it remains rigid when loaded.

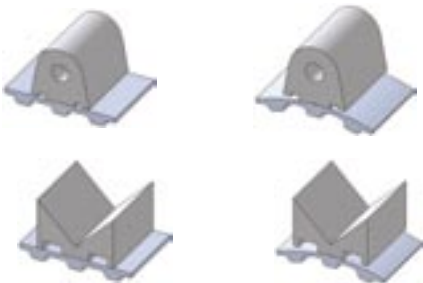

5. Segmented Profiles

When large profiles are required as carriers, they must be either segmented or slotted. This is necessary to allow flexing around the pulley. On the flat conveyor surface, the profiles remain intact.

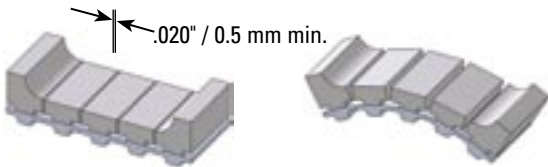

6. Profiles With Holes

Profiles with holes for securing paddles or other attachments can be produced. Holes are either drilled before bonding, or are molded into the profile depending upon the volume and requirements of the application.

Tolerances of the hole placement depends upon whether the holes are drilled or molded. The tolerance of the hole from the belt surface is subject to the bonding process of the profile foot and the belt surface.

Generally, tolerances are as shown below. However, tighter tolerances are possible. Please consult our Applications Engineering Department.

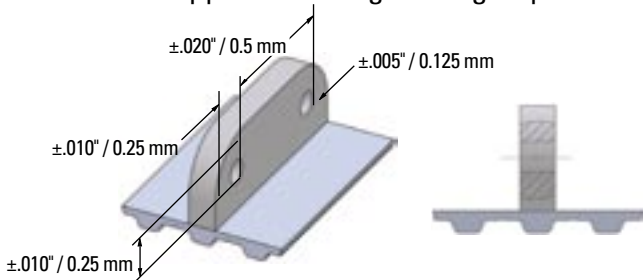

7. Profiles With Inserts

Profiles can be molded with metallic inserts. These are particularly useful in some applications to replace attachment chain.

The actual inserts can either be manufactured by Gates Mectrol or provided by the customer.

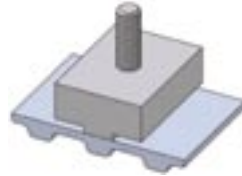

8. Flash Bead

During the welding process, a bead of polyurethane develops at the meeting point of the profile and belt.

Flash bead removed on demand.

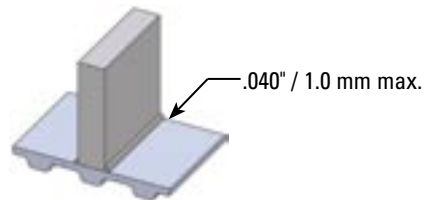

9. Perpendicularity

All profiles are perpendicular to 1°.

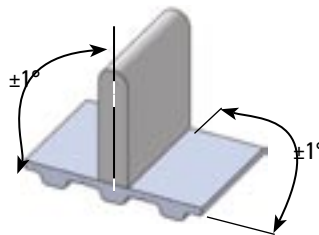

10. Ordering

When ordering a profiled belt, it is advisable to submit a drawing of the profiled belt. For your convenience, standard drawing forms are available from our Applications Engineering Department.

Once a design is finalized, Gates Mectrol will submit a drawing to the customer for approval. This custom belt drawing number should then be used for future ordering.

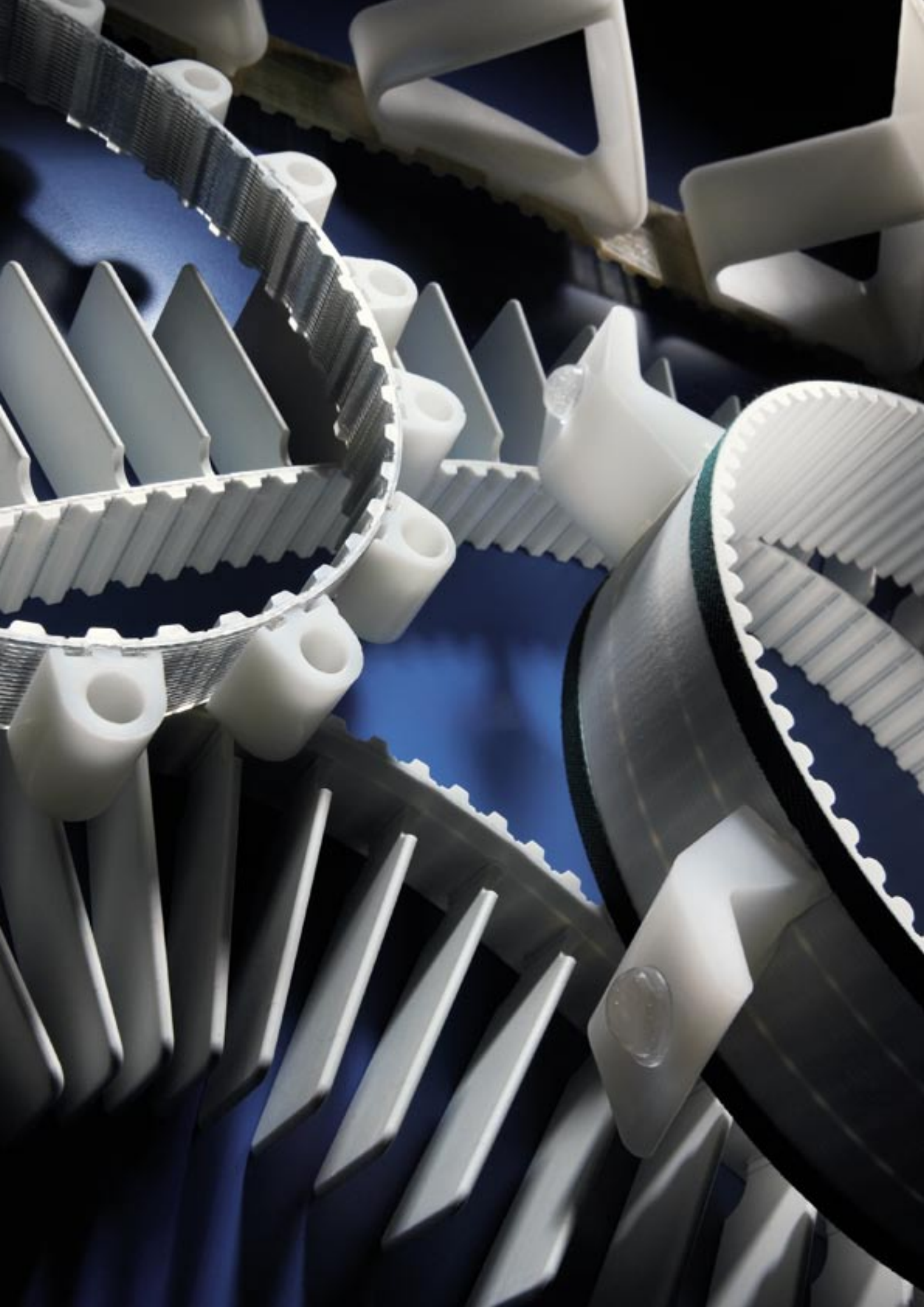

Profiled Belts – Examples

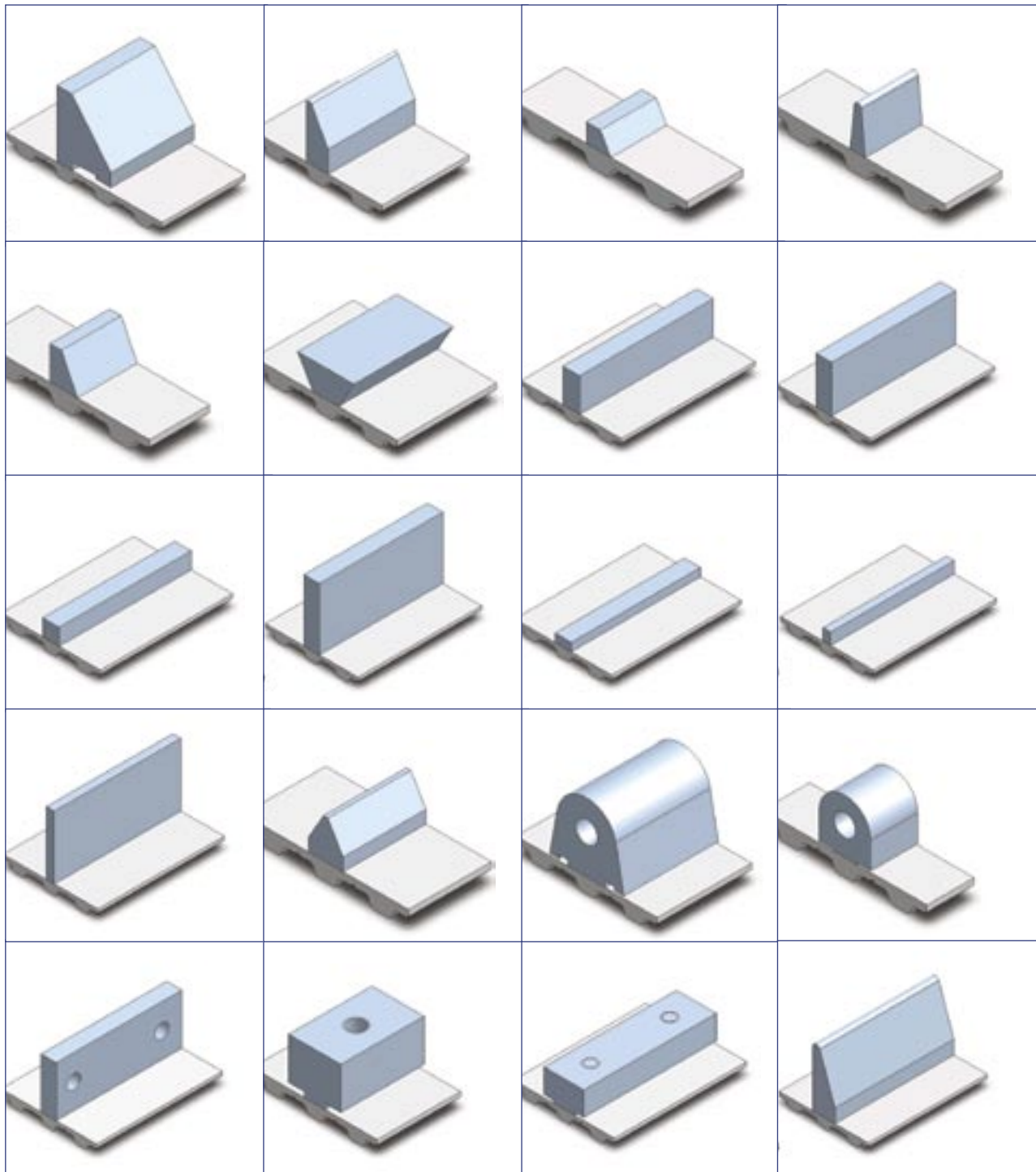

Backings

Most belt types can be modified by adding a backing to achieve a desired coefficient of friction, abrasion resistance or cushion. A backing can also be added and then milled to create pockets for product transfer. Gates Mectrol offers over 20 backings to meet your needs.

Application Characteristics

- High friction for feeding or separating applications
- Low friction for light feed or accumulation requirements
- Ability to conform to unusual product shapes
- Combine friction with vacuum for ultimate grab

Features

A customized backing can provide:

- A dramatic increase or decrease in the coefficient of friction
- Varying levels of cushioning and durability through material thickness and hardness selection
- Static conductivity
- Various levels of chemical resistance
- An ability to alter wear characteristics

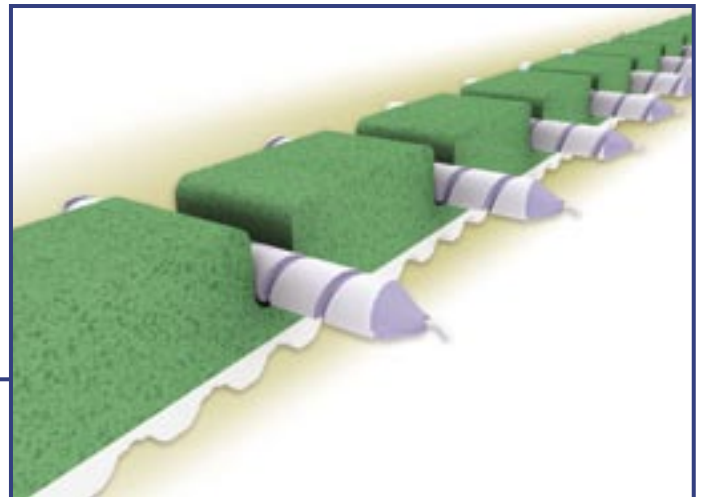

A unique foam backing is used to carefully grasp and transport candles for cooling.



Its combined characteristics of high friction and abrasion resistance make the Linatex® backing ideal for box folding applications.



Backings

Perform a wide variety of functions

Many applications require belts with specific surface characteristics. A wide variety of co-extruded as well as post-laminated backings are available to solve your toughest application requirements. Specifications follow.

- Special Nylon® fabric can be added to the belt back or tooth side during the manufacturing process. This reduces the coefficient of friction for sliding surfaces or product accumulation
- High friction surfaces
- A variety of materials can be added for vibration dampening

Polyurethane

Gates Mectrol polyurethane backings are available in several different varieties. Available in different durometers, with different coefficients of friction, polyurethane backings are the toughest and most durable backing material.

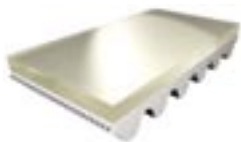

Clear Polyurethane



Glass Backing



Ridge Top



White Polyurethane

Rubber

Feeding applications generally require extremely high friction. Rubber can provide this high friction, even while wet. Some rubber backings also offer antistatic properties, higher temperature ratings, and good chemical and abrasion resistance.



Linatex®



Linaplus FG™



Tan Natural Rubber



Nitrile Rubber

Backings

Foam

Many applications require a combination of friction and the ability to conform to unusual product shapes. Gates Mectrol foam backings are available in different densities for various compliance, cushioning and friction surfaces. Belts can be constructed with a foam layer for cushioning and a tougher high friction outer layer.

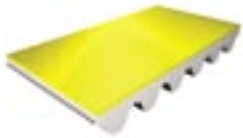

HD Yellow



HD Gray



Yellow



Blue



Green



Brown



Red



Neoprene



Natural

PVC

Available with unusual surface patterns and characteristics, PVC backings offer a well bonded, economical solution with very good wear properties.

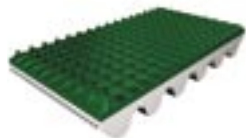

Rough Top



Small Pebble



Large Pebble



Herringbone



Blue PVC



White PVC

Specialty Backings



Novo Backing



Linatril®



PVC Saw Tooth

Further backings on request
e.g.: Rubber Rough Top
Chrome Leather

Backings – Specifications

Relative Hardness

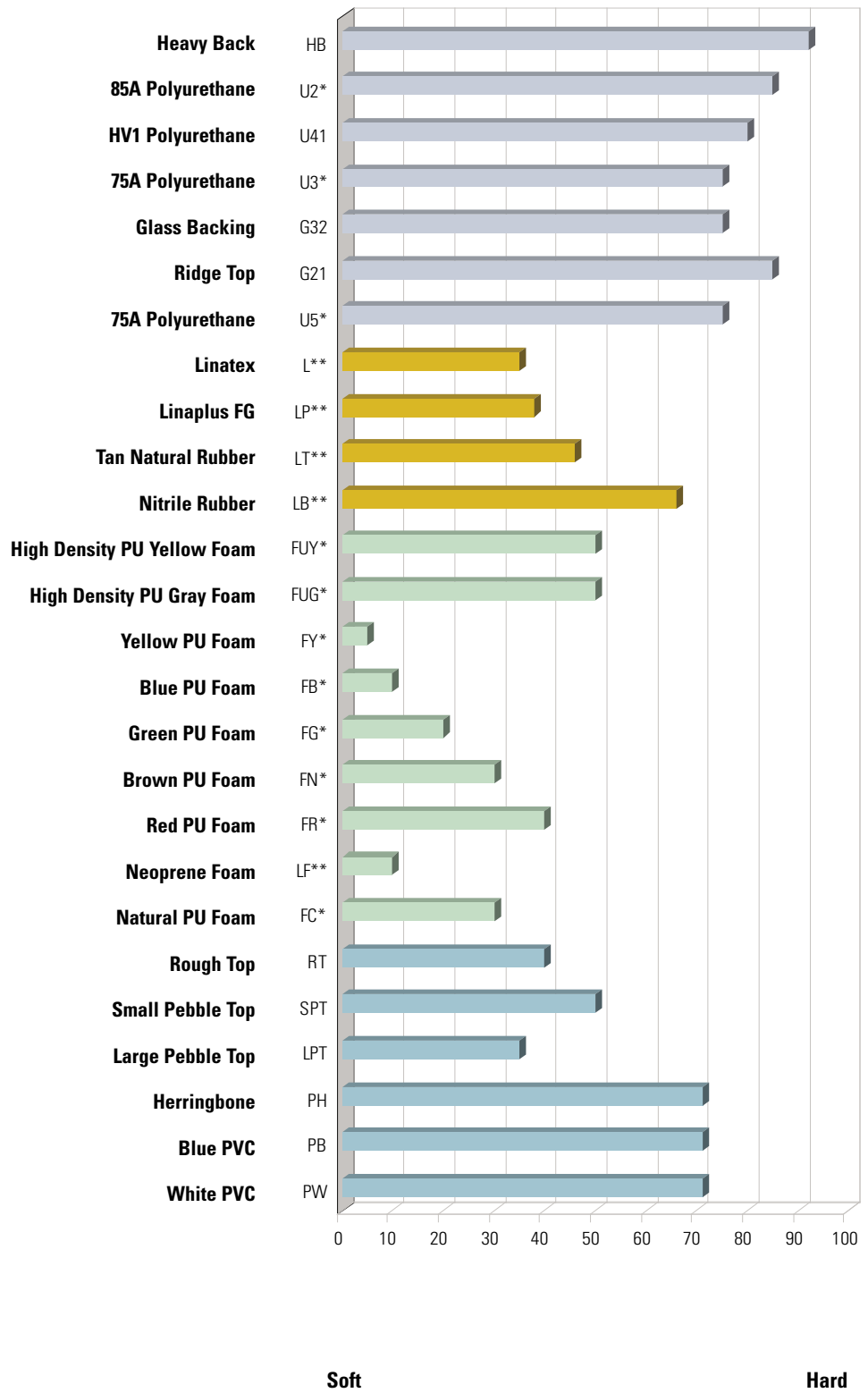

Backings – Specifications

Relative Abrasion Resistance

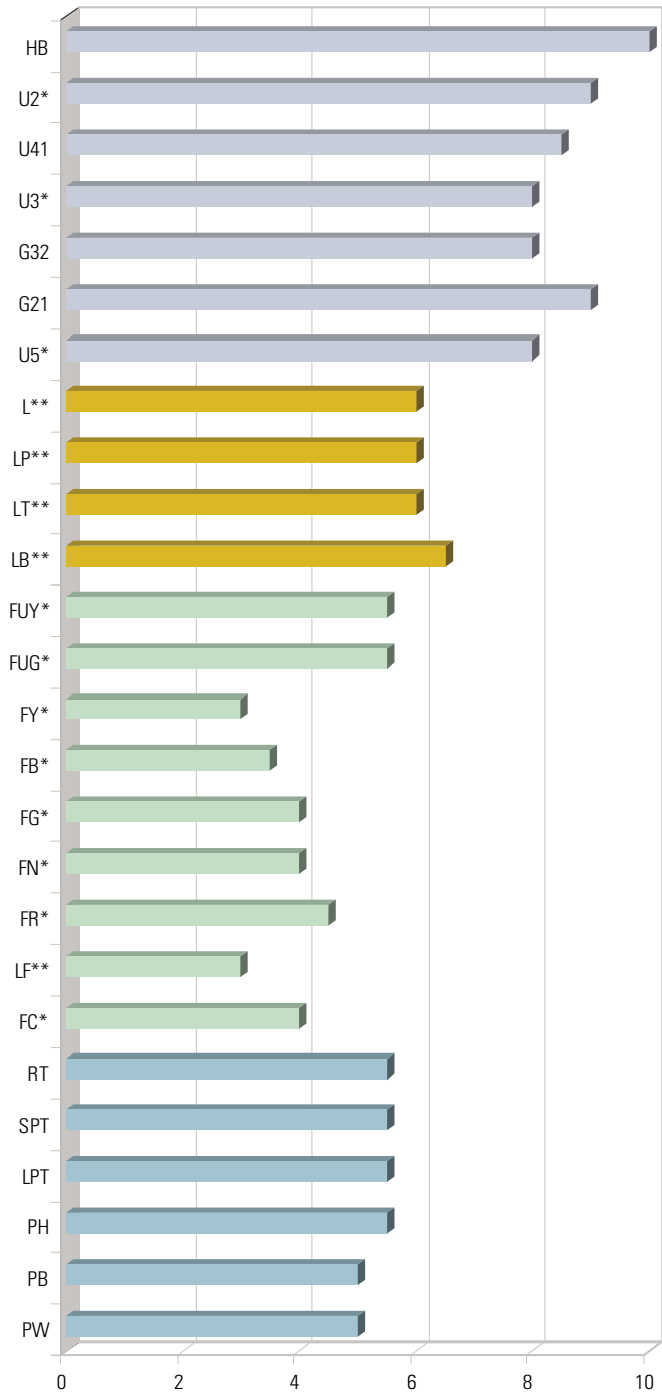

Poor

Excellent

Static Coefficient of Friction

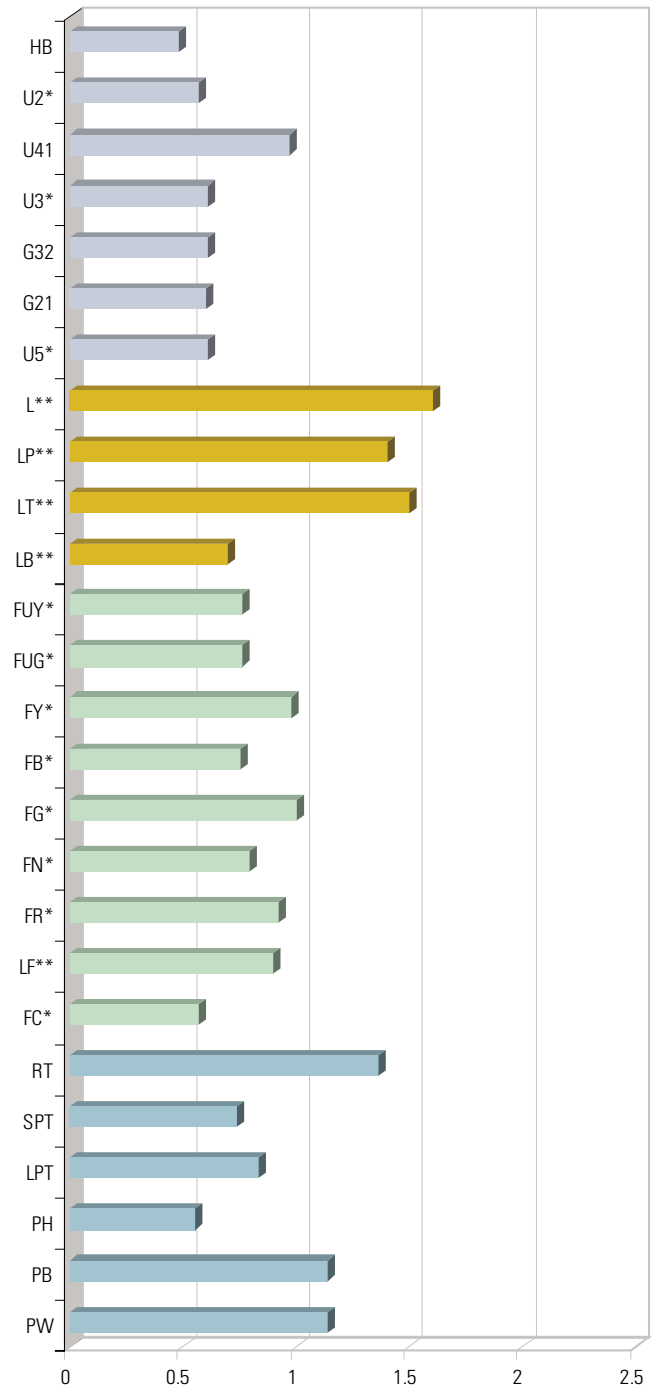

Static friction measured against aluminum

Backings – Specifications

Polyurethane

Heavy Back	HB	Same as standard 92 A hardness base material. Very tough and durable.
85A Polyurethane	U2*	Softer PU than base material. Higher friction, more flexibility, similar durability.
HV1 Polyurethane	U41	Specifically compounded for very high coefficient of friction.
75A Polyurethane	U3*	Softer version of standard urethane. Better friction, more compression, greater flexibility, very tough.
Glass Backing	G32	Longitudinal groove pattern for glass conveying. Good friction and gaps for holding back abrasives and dirt.
Ridge Top	G21	Durable backing with longitudinal ridges. Ideal for conveying oily steel.
75A Polyurethane	U5*	Softer, high friction with very good abrasion resistance.

Rubber

Linatex®	L**	High friction, pure gum rubber. Good abrasion resistance, excellent for pulling and feeding applications.
Linaplus FG	LP**	FDA approved, high friction pure gum rubber.
Tan Natural Rubber	LT**	Natural pure gum rubber, high friction.
Nitrile Rubber	LB**	Oil and fuel resistant synthetic rubber

Foam

High Density PU Yellow Foam	FUY*	High friction. Very good abrasion resistance, excellent for paper feed applications.
High Density PU Gray Foam	FUG*	High friction. Very good abrasion resistance, excellent for paper feed applications.
Yellow PU Foam	FY*	Lower density. Excellent cushioning and conforming to products while providing good friction.
Blue PU Foam	FB*	Low density. Excellent cushioning and conforming to products while providing good friction.
Green PU Foam	FG*	Mid range density, firmer holding and cushioning, excellent friction.
Brown PU Foam	FN*	Mid range density, firmer holding and cushioning, excellent friction.
Red PU Foam	FR*	Upper range density, firm holding and cushioning, good friction and abrasion resistance.
Neoprene Foam	LF**	Black neoprene good abrasion resistance, compliance.
Natural PU Foam	FC*	Mid range density. Less demanding applications.

PVC

Rough Top	RT	Intricate surface modeling, excellent friction surfaces. Great for glass and incline conveyors.
Small Pebble Top	SPT	Textured surface with small nubs for non-slip surface.
Large Pebble Top	LPT	Textured surface with larger nubs for non-slip surface.
Herringbone	PH	Raised herringbone pattern for non-slip and dispersing surface.
Blue PVC	PB	Smooth high sheen, high friction surface.
White PVC	PW	Smooth white, FDA high friction surface for non-abrasive applications.

Backings – Specifications

	Hardness Shore A / Density Kg/m ³	Material Thickness mm	Abrasion Resistance Rating ‡	Static Coefficient of Friction †	Kinetic Coefficient of Friction †	Max. Temp. Degrees C	Pulley Diameter Factor	Oil Resistance	Color
Polyurethane									
HB	92	2	10	0.5	0.5	70	30	E	Clear
U2*	85	2 or 3	9	0.6	0.5	70	30	E	Clear
U41	80	1	8.5	1.0	0.8	70	30	E	Clear
U3*	75	2 or 3	8	0.6	0.6	70	30	E	Clear
G32	75	5	8	0.6	0.6	70	Ø100mm	E	Clear
G21	85	3	9	0.6	0.5	70	Ø100mm	E	Clear
U5*	75	2 or 3	8	0.6	0.6	70	25	E	White

Rubber

L**	35	1/16" to 1/2" 1,6 to 12,7 mm	6	1.6	1.6	60	20	P	Red
LP**	38	1/16" to 3/16" 1,6 to 4,8 mm	6	1.4	1.4	60	20	P	White
LT**	45	1/16" to 1/4" 1,6 to 6,4 mm	6	1.5	1.5	60	20	P	Tan
LB**	65	1/16" to 1/4" 1,6 to 6,4 mm	6.5	0.7	0.5	110	25	E	Black

Foam

FUY*	50	2 to 5	5.5	0.8	0.8	60	30	E	Yellow
FUG*	50	2 to 5	5.5	0.8	0.8	60	30	E	Gray
FY*	- / 160	6 to 12	3	1.0	1.0	60	15	E	Yellow
FB*	- / 220	6 to 12	3.5	0.8	0.8	60	15	E	Blue
FG*	20 / 300	6 to 12	4	1.0	1.0	60	15	E	Green
FN*	30 / 400	6 to 12	4	0.8	0.8	60	15	E	Brown
FR*	40 / 500	6 to 12	4.5	0.9	0.9	60	20	E	Red
LF**	- / 250	1/8" to 1/2" 3,2 to 12,7 mm	3	0.9	0.9	60	15	A	Black
FC*	30 / 400	2 to 5	4	0.6	0.5	60	15	E	Natural

PVC

RT	40	4.5	5.5	1.4	1.3	60	Ø 90mm	P	Blue-green
SPT	50	1.5	5.5	0.7	0.6	60	Ø 25mm	P	White
LPT	35	6	5.5	0.8	0.7	60	Ø 40mm	P	White
PH	70	4.5	5.5	0.6	0.3	60	Ø 90mm	P	White
PB	70	1 or 2	5	1.1	1.1	60	Ø 40mm	P	Blue-green
PW	70	2	5	1.1	1.1	60	Ø 40mm	P	White

* Add thickness in mm to designator

** Add thickness in 1/16" /1,6 mm to designator

‡ 10 = very high resistance

† Friction measured against aluminum

Oil resistance: E = Excellent G = Good P = Poor A = Acceptable

Minimum Pulley Diameter = (Pulley Diameter Factor) x (Material Thickness)
or above listed diameter

Note: Pulley diameter must be greater than or equal to the minimum pulley
required for a given belt type. See belt specifications.

Fabrication Capabilities

Gates Mectrol offers a wide range of belt modifications and a full range of secondary fabrication possibilities.

Whether grinding edges and surfaces to tight tolerances, punching and machining holes and slots, or CNC machining of three dimensional contours, Gates Mectrol can provide a complete solution.

Features

- Nearly unlimited customizing options
- Ground tolerances on nearly any dimension for extra precision
- Unusual shapes, contours and configurations
- Holes, slots, and any CNC machined shape in the belt surface
- Combination of primary tooling and secondary machining to achieve any design potential

Application Characteristics

- Vacuum conveying belts
 - Machined tooth side and perforations
- Precision machined belts for precise movement of product
- Distinct product orientation and location for automated process steps

Battery conveying: custom ground polyurethane belt holds and transports batteries.

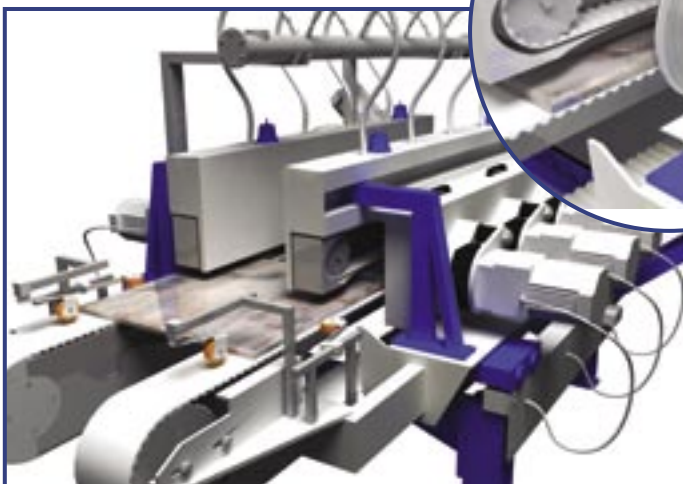
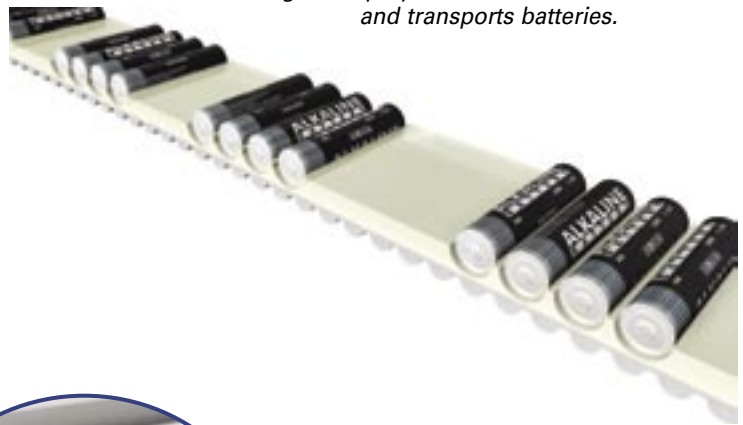

Tile squaring machine utilizes custom belts with precision ground thickness and width.



Truly Endless Belt Overview

Gates Mectrol recently introduced the next generation of polyurethane sleeve timing belts, named **Gates Synchro-Power®**.

Advantages of the new sleeve include:

- *Industry leading 400mm width*
- *Higher abrasion resistance*
- *UV stabilizer additive*

Certain power transmission and high performance positioning applications require more strength and stiffness than a welded belt can provide. Gates Mectrol offers two types of truly endless belts to meet these needs.

- **Gates Synchro-Power®** belts are cast on fixed molds and have a continuously wound steel or Kevlar® cord. They are available in stock sizes.
- **Flex** belts are extruded to custom lengths ranging from 2.5 to 12.5 meters. A unique process provides the flexibility to have custom sized belts without expensive tooling.

Application Characteristics

- Power transmission
- High power, high performance conveying
- Harsh environments
 - Abrasion and chemical resistance

Features

- Helically wound cords for high strength, truly endless power transmission capabilities
- High quality, thermo-set polyurethane designed specifically for timing belt applications (Gates Synchro-Power®) or thermoplastic polyurethane for longer length belts (Flex)
- Available with either steel or Kevlar® reinforcement
- Standard molded sleeves (Gates Synchro-Power®) or custom length belts available - up to 12.5 meters (Flex)
- Nylon® tooth surface option available on Flex belts for quieter operation



Double sided, truly endless, polyurethane timing belts are used in the textile industry for fiber winding.



Gates Synchro-Power® (Cast) Belts

Gates Synchro-Power® belts, **cast belts**, are produced on dedicated tooling and are available from stock in the sizes listed. For belt lengths not listed, please consult a Gates Mectrol applications engineer.

Belt Length (mm)				Belt Length (mm)				Belt Length (mm)			
No. of Teeth	T2.5	T5	T5 DL	No. of Teeth	T2.5	T5	T5 DL	No. of Teeth	T2.5	T5	T5 DL
30		150		84		420		138		690	
33		165		89		445		140		700	
36		180		90		450		144		720	
37		185		91		455		145		725	
40		200		92	230		460	150		750	750
43		215		95		475		152	380		
44		220		96		480	480	156		780	
45		225		98	245			160		800	
48	120			100		500		163		815	815
49		245		102		510		168	420	840	
50		250		103			515	170		850	
51		255		105		525		172			860
52		260		106	265			180		900	
54		270		109		545		188		940	940
55		275		110		550		192	480		
56		280		112		560		198		990	
59	145	295		114	285			200	500		
61		305		115		575		215		1075	
63		315		118		590	590	220		1100	1100
64	160			120		600		240	600		
66		330		122	305	610		243		1215	
68		340		124		620	620	248	620		
70		350		126		630		260	650		
71	177.5	355		127	317.5			263		1315	
73		365		128		640		276		1380	
78		390		130		650		312	780		
80	200	400		132	330	660		366	915		
82		410	410	135		675		380	950		

To Order Gates Synchro-Power® Belts

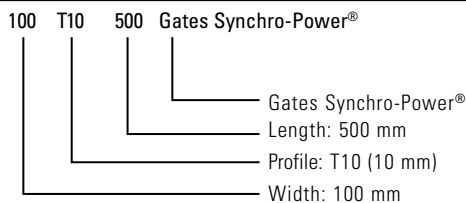

Gates Synchro-Power® (Cast) Belts

Belt Length (mm)		
No. of Teeth	T10	T10 DL
26	260	260
37	370	
40	400	
41	410	
44	440	
45	450	
50	500	
53	530	530
56	560	
60	600	
61	610	
63	630	630
66	660	660
69	690	
70	700	
72	720	720
73	730	
75	750	
78	780	
80	800	
81	810	
84	840	840
85	850	
88	880	
89	890	
90	900	
91	910	
92	920	
95	950	
96	960	

Belt Length (mm)		
No. of Teeth	T10	T10 DL
97	970	
98	980	980
100	1000	
101	1010	
108	1080	
110	1100	
111	1110	
114	1140	
115	1150	
121	1210	1210
124	1240	1240
125	1250	1250
130	1300	
132	1320	1320
135	1350	1350
139	1390	
140	1400	
142	1420	1420
145	1450	
146	1460	
150	1500	
156	1560	
160	1600	
161	1610	1610
170	1700	
175	1750	
178	1780	
188	1880	1880
196	1960	
225	2250	

Belt Length (mm)		
No. of Teeth	AT5	AT10
45	225	
50		500
51	255	
55	275	
56	280	560
60	300	
61		610
66		660
68	340	
70		700
73		730
75	375	
78	390	780
80		800
81		810
84	420	840
89		890
91	455	
92		920
96		960
98		980
100	500	
101		1010
105		1050
108		1080
109	545	
115		1150
120	600	1200
121		1210
122	610	
125		1250
126	630	
132	660	1320
140		1400
144	720	
150	750	1500
156	780	
160		1600
165	825	
170		1700
180		1800
195	975	
210	1050	
225	1125	
300	1500	

Available Widths

	Min.	Max.
T2.5	4 mm	200 mm
T5	6 mm	400 mm
T10	10 mm	400 mm
AT5	6 mm	400 mm
AT10	16 mm	400 mm

* Selected belts are available up to 200 mm width

Gates Synchro-Power® (Cast) Belts

Most Gates Synchro-Power® belts are available with Kevlar® as well as steel reinforcing cords.

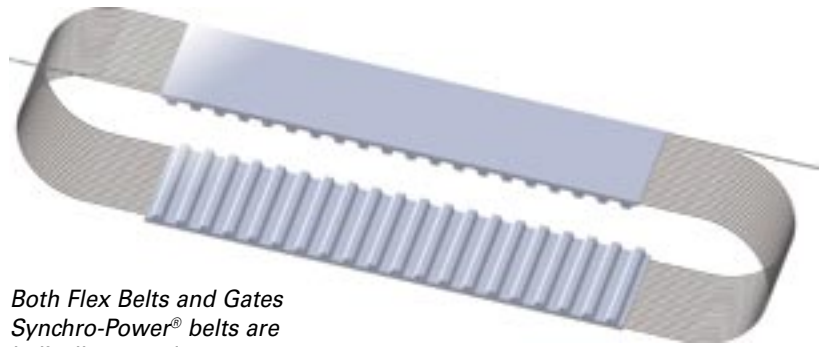

Both Flex Belts and Gates Synchro-Power® belts are helically wound.

Gates Synchro-Power® Specifications

			T2.5	T5	T5 DL	AT5	T10	T10 DL	AT10
Pitch			2.5 mm	5 mm	5 mm	5 mm	10 mm	10 mm	10 mm
Ultimate Tensile Strength per Inch or 25 mm Belt Width	Steel	lbf/in N/25 mm	260 1160	740 3290	740 3290	1360 6050	1650 7340	1650 7340	2250 10010
	Kevlar®	lbf/in N/25 mm	N/A N/A	1210 5380	1210 5380	N/A N/A	1490 6630	1490 6630	N/A N/A
Max Allowable Tension per Inch or 25 mm Belt Width	Steel or Kevlar®	lbf/in N/25 mm	60 270	180 800	180 800	340 1510	410 1820	410 1820	560 2490
Allowable Effective Tension for Belt Teeth (15 and More Teeth in Mesh)		lbf/in N/25 mm	60 270	200 890	200 890	290 1290	380 1690	380 1690	580 2580
Specific Belt Weight	Steel	lbf/ft/in kg/m/cm	0.024 0.014	0.035 0.021	0.044 0.026	0.058 0.034	0.075 0.044	0.101 0.059	0.111 0.065
	Kevlar®	lbf/ft/in kg/m/cm	N/A N/A	0.033 0.020	0.037 0.023	N/A N/A	0.062 0.036	0.082 0.048	N/A N/A
Minimum Number of Pulley Teeth			12	10	12	15	14	18	15
Min. Pitch Diameter			10 mm	16 mm	20 mm	24 mm	45 mm	57 mm	48 mm
Minimum Diameter of Tension Idler Running on Back of Belt		inch mm	0.787 20	1.125 30	0.787 20	2.375 60	3.125 80	2.250 57	4.750 120
Service Temperature Range			-5°C to +70°C (23°F to 158°F)						
Hardness			90 Shore A						
Standard Color			Blue						

The specifications listed are based on Gates Mectrol's experience. However, our specifications and data do NOT cover all possible belt drive conditions. It is the responsibility of the belt drive system designer to ensure Gates Mectrol's belts are appropriate for a given system and application. The provided data is representative of our in-house experience and does not necessarily match product performance in industrial use. Gates Mectrol cannot assume any liability concerning the suitability and process ability of our products. We also cannot assume liability for process results, damages or consequential damages associated with the use of our products.

Flex Belts

Flex Belts are produced with steel cords and the same tough polyurethane as Gates Mectrol's standard linear belts.

	L	H	XH	T5*	AT5*	T10	T10-HF	AT10	T20	AT20	HTD®5*	HTD®8
Minimum Length mm	99.0" 2500	61.0" 1549,4	99.0" 2500	1550	1550	1550	2500	1550	1540	1540	1550	1552
Maximum Length mm	492" 12500	925" 23495	492" 12500	23500	23500	23500	12500	23500	23500	23500	23500	23504
Minimum Width mm	.25" 6.35	.50" 12.7	1.0" 25.4	10	10	10	10	16	16	25	10	16
Maximum Width mm	4.0" 101.6	4.0" 101.6	4.0" 101.6	100	100	100	100	100	150	150	150	150

Flex Specifications

	L	H	XH	T5	AT5	T10	T10-HF	AT10	T20	AT20	HTD5	HTD8	
Pitch (Imperial and metric)	.375"	.500"	.875"	5 mm	5 mm	10 mm	10 mm	10 mm	20 mm	20 mm	5 mm	8 mm	
Ultimate Tensile Strength per Inch or 25 mm Belt Width	lbf/in N/25 mm	1220 5430	1570 6980	2760 12280	800 3560	1220 5430	1570 6980	2380 10590	2760 12280	2760 12280	4310 19170	2380 10590	2570 11430
Max Allowable Tension per Inch or 25 mm Belt Width	lbf/in N/25 mm	300 1330	390 1730	690 3070	200 890	300 1330	390 1730	590 2620	690 3070	690 3070	1070 4760	590 2620	640 2850
Allowable Effective Tension for the Belt Teeth (15 and More Teeth in Mesh)	lbf/in N/25 mm	360 1600	440 1960	880 3910	200 890	290 1290	380 1690	380 1690	580 2580	710 3160	1220 5430	230 1020	420 1870
Specific Belt Weight	lbf/ft/in kg/m/cm	0.059 0.035	0.066 0.039	0.180 0.105	0.037 0.022	0.055 0.032	0.074 0.043	0.079 0.046	0.096 0.056	0.125 0.073	0.169 0.099	0.070 0.041	0.101 0.059
Min. Number of Pulley Teeth		10	14	18	10	15	14	12	15	15	18	14	20
Min. Pitch Diameter		1.19" 30.25 mm	2.23" 56.64 mm	5.01" 127.25 mm	16 mm	24 mm	45 mm	38 mm	48 mm	96 mm	115 mm	22 mm	51 mm
Minimum Diameter of Tension Idler Running on Back of Belt	inch mm	2.375 60	3.125 80	5.875 150	1.125 30	2.375 60	3.125 80	2.375 60	4.750 120	4.750 120	7.125 180	2.375 60	4.750 120
Service Temperature Range	-5°C to +70°C (23°F to 158°F)												
Standard Color	White												

To Order Flex Belts (Imperial Pitch)

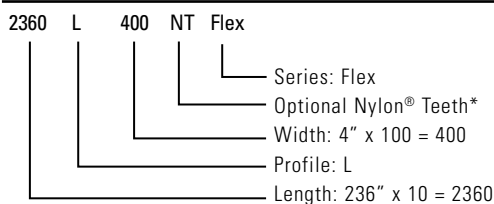

To Order Flex Belts (HTD®- Pitch)

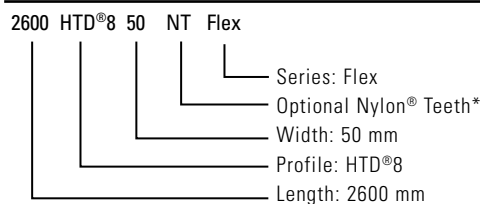

To Order Flex Belts (Metric Pitch)

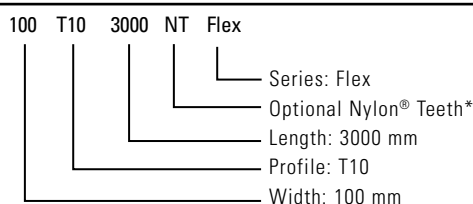

*on request

Technical Design Tools Online

Gates Mectrol's belt design tools make selecting the right belt for your application easy anytime.

Gates Mectrol offers online design tools for calculating all types of polyurethane timing belt applications.

These design tools are, by far, industry state-of-the-art, offering the most comprehensive, easy to use and accurate calculations available.

For linear and rotary positioning applications, synchronous conveying or power transmission, simply enter all of your known parameters, and these programs will guide you through step-by-step calculations, resulting in the selection of the most appropriate belt for your application.

Included with your output will be information which is "total system" inclusive, providing necessary data for selecting all related drive components, as well as for programming electronic controls.

Log on to www.gatesmectrol.com today, and register for instant access to the industry's best calculation tools available.



>> To access our design tools online visit <http://apps.gatesmectrol.com>

Calculation

Many conveying timing belts operate at low speeds and minimal loads. This eliminates the need for extensive calculations and a simplified approach to belt selection can be used. For these lightly loaded applications, the belt can be selected according to the dimensional requirements of the system, product size, desired pulley diameter, conveyor length, etc.

The belt width b is often determined according to the size of the product conveyed, and as a rule, the smallest available belt pitch is used. For proper operation, the pre-tension T_i should be set as follows:

$$T_i \approx \frac{0.3 \cdot b \cdot T_{1all}}{25}$$

where: T_i = belt pre-tension
 T_{1all} = max allowable belt tension for 1" or 25mm wide belt (see Table 1 or Table 2)

U.S. customary units: T_i [lb], T_{1all} [lb/in], b [in]
 Metric units: T_i [N], T_{1all} [N/25mm], b [mm].

For all applications where the loads are significant, the following step-by-step procedure should be used for proper belt selection.

Step 1. Determine Effective Tension

The effective tension T_e at the driver pulley is the sum of all individual forces resisting the belt motion. The individual loads contributing to the effective tension must be identified and calculated based on the loading conditions and drive configuration. However, some loads cannot be calculated until the layout has been decided.

To determine the effective tension T_e use one of the following methods for either conveying or linear positioning.

Conveying

T_e for conveying application is primarily the sum of the following forces (see Figs. 1 and 2).

1. The friction force F_f between the belt and the slider bed resulting from the weight of the conveyed material.

$$F_f = \mu \cdot w_m \cdot L_m \cdot \cos\beta$$

where: μ = coefficient of friction between the slider bed and the belt (see page 8)

w_m = load weight per unit length over conveying length

L_m = conveying length

β = angle of conveyor incline

U.S. customary units: F_f [lb], w_m [lb/ft], L_m [ft].

Metric units: F_f [N], w_m [N/m], L_m [m].

2. The gravitational load F_g to lift the material being transported on an inclined conveyor.

$$F_g = w_m \cdot L_m \cdot \sin\beta$$

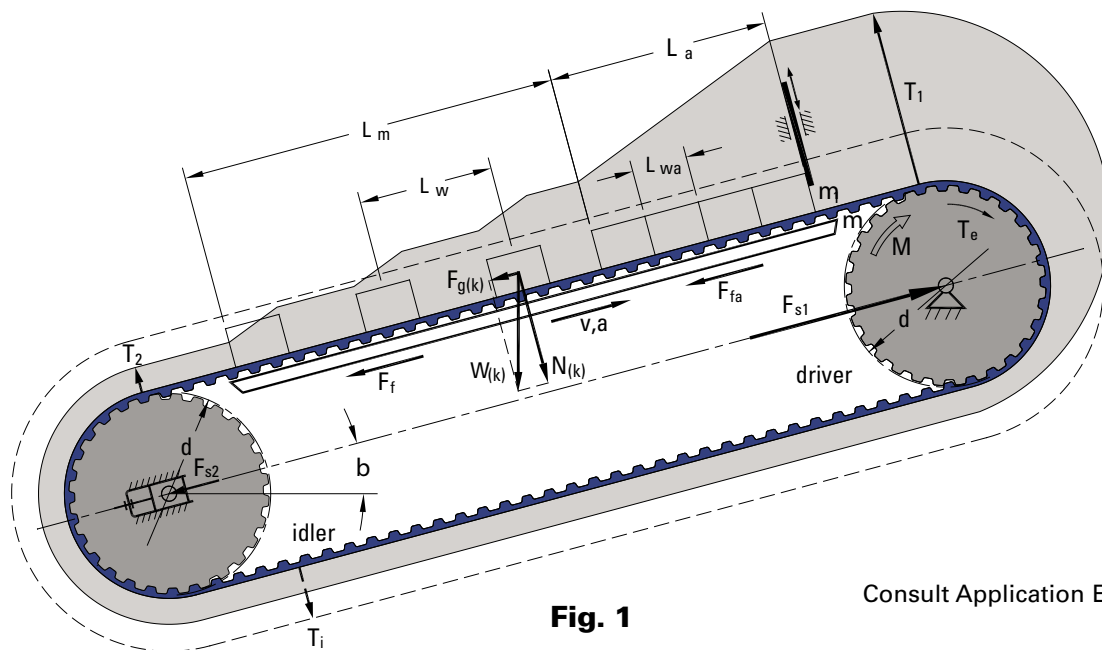

Fig. 1

Consult Application Engineering

Calculation

3. The friction force F_{fv} resulting from vacuum in vacuum conveyors.

$$F_{fv} = \mu \cdot P \cdot A_v$$

where: P = pressure (vacuum) relative to atmospheric
 A_v = total area of vacuum openings

U.S. units: F_{fv} [lb], P [lb/ft²], A_v [ft²]

Metric units: F_{fv} [N], P [Pa], A_v [m²]

The formula above assumes a uniform pressure and a constant coefficient of friction.

4. The friction force F_{fa} over the accumulation length in material accumulation applications.

$$F_{fa} = (\mu + \mu_a) \cdot w_{ma} \cdot L_a \cdot \cos\beta$$

where: L_a = accumulation length
 μ_a = friction coefficient between accumulated material and the belt (see Table 1A)
 w_{ma} = material weight per unit length over the accumulation length

U.S. customary units: L_a [ft], w_{ma} [lb/ft].

Metric units: L_a [m], w_{ma} [N/m].

5. The inertial force F_a caused by the acceleration of the conveyed load (see linear positioning).

6. The friction force F_{fb} between belt and slider bed caused by the belt weight.

$$F_{fb} = \mu \cdot w_b \cdot b \cdot L_c \cdot g \cdot \cos\beta$$

where: w_b = specific belt weight
 b = belt width
 L_c = conveying length

U.S. customary units: w_b [lb/ft/in], b [in], L_c [ft].

Metric units: w_b [kg/m/cm], b [cm], L_c [m].*

For initial calculations, use belt width which is required to handle the size of the conveyed product.

Thus for conveyors, T_e is expressed by:

$$T_e = F_f + F_g + F_{fv} + F_{fa} + F_a + (F_{fb}) + \dots$$

F_{fb} can be calculated by estimating the belt mass. In most cases, this weight is insignificant and can be ignored.

Note that other factors, such as belt supporting idlers, or accelerating the material fed onto the belt, may also account for some power requirement. In start-stop applications, acceleration forces as presented for linear positioning, may have to be evaluated.

Linear Positioning

T_e for a linear positioning application is primarily the sum of the following six factors (see Fig. 3).

1. The force F_a required for the acceleration of a loaded slide with the mass m_s (replace the mass of the slide with the mass of the package in conveying).

$$F_a = m_s \cdot a$$

The average acceleration a is equal to the change in velocity per unit time.

$$a = \frac{v_f - v_i}{t}$$

where: v_f = final velocity
 v_i = initial velocity
 t = time

U.S. customary units: F_a [lb], a [ft/s²], v_f and v_i [ft/s], t [s].

Metric units: F_a [N], a [m/s²], v_f and v_i [m/s], t [s], m_s [kg].

2. The friction force F_f between the slide and the linear rail is determined experimentally, or from data from the linear bearing manufacturer. Other contributing factors to the friction force are bearing losses from the yolk, piston and pillow blocks (see Fig. 3).

3. The externally applied working load F_w (if existing).

4. The weight W_s of the slide (not required in horizontal drives).

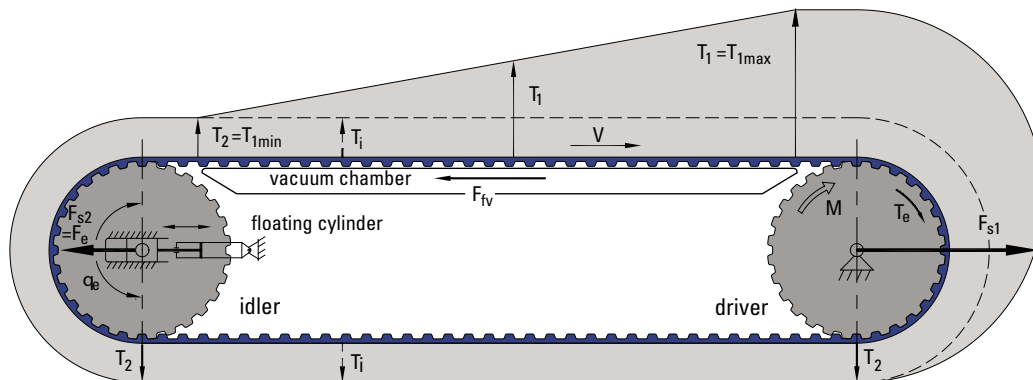

Fig. 2

Calculation

5. The force F_{ai} required to accelerate the idler.

$$F_{ai} = \frac{J_i \cdot \alpha}{r_o} = \frac{m_i \cdot r_o^2}{2 \cdot r_o} \cdot \frac{\alpha}{r_o} = \frac{m_i \cdot \alpha}{2}$$

where: $J_i = \frac{m_i \cdot r_o^2}{2}$ = inertia of the idler
 m_i = mass of the idler
 r_o = idler outer radius
 $\alpha = \frac{a}{r_o}$ = angular acceleration

In the formula above, the mass of the idler m_i is approximated by the mass of a full disk.

6. The force F_{ab} required to accelerate the belt mass.

$$F_{ab} = m_b \cdot a$$

The belt mass m_b is obtained from the specific belt weight w_b and belt length and width.

U.S. units: F_{ab} [lb], a [ft/s²]

Metric units: F_{ab} [N], m_b [kg], a [m/s²]

Thus for linear positioners, T_e is expressed by:

$$T_e = F_a + F_f + F_w + W_s + [F_{ai}] + [F_{ab}]$$

Note that the forces in brackets can be calculated by estimating the belt mass and idler dimensions. In most cases, however, they are negligible and can be ignored.

Step 2. Select Belt Pitch

Use Graphs 2a, 2b, 2c or 2d (pages 54 to 57) to select the nominal belt pitch p according to T_e . The graphs also provide an estimate of the required belt width. (For H pitch belts wider than 6" (152.4mm) and T10 pitch belts wider than 150mm, use Graph 1, page 53).

Step 3. Calculate Pulley Diameter

Use the preliminary pulley diameter \tilde{d} desired for the design envelope and the selected nominal pitch p to determine the preliminary number of pulley teeth \tilde{z}_p .

$$\tilde{z}_p = \frac{\pi \cdot \tilde{d}}{p}$$

Round to a whole number of pulley teeth z_p . Give preference to stock pulley diameters. Check against the minimum number of pulley teeth z_{min} for the selected pitch given on page 8/9.

Determine the pitch diameter d according to the chosen number of pulley teeth z_p .

$$d = \frac{p \cdot z_p}{\pi}$$

Step 4. Determine Belt Length and Center Distance

Use the preliminary center distance \tilde{C} desired for the design envelope to determine a preliminary number of belt teeth \tilde{z}_b .

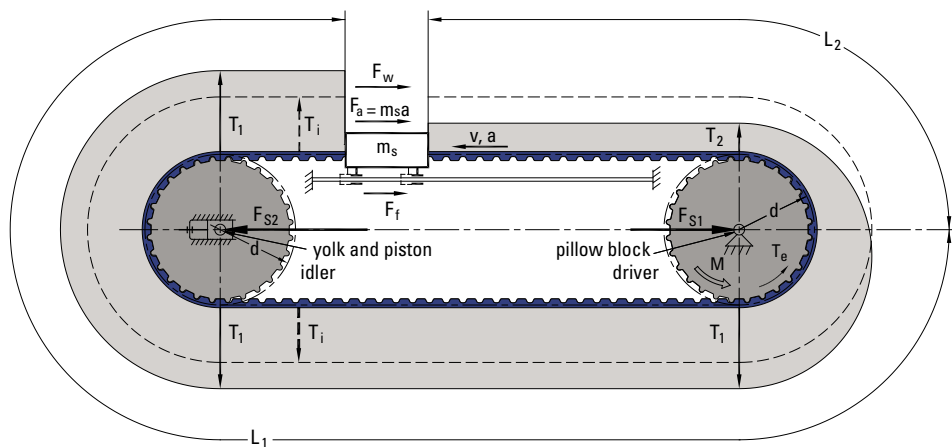

Fig. 3

Calculation

For equal diameter pulleys:

$$\bar{z}_b = 2 \cdot \frac{\bar{C}}{p} + z_p$$

For unequal diameter pulleys: (See Fig. 4)

$$\bar{z}_b \approx 2 \cdot \frac{\bar{C}}{p} + \frac{z_{p2} + z_{p1}}{2} + \frac{p}{4C} \cdot \left(\frac{z_{p2} - z_{p1}}{\pi} \right)^2$$

Choose a whole number of belt teeth z_b . If you have profiles welded to the belt, consider the profile spacing while choosing the number of belt teeth.

Determine the belt length L according to the chosen number of belt teeth.

$$L = z_b \cdot p$$

Determine the center distance C corresponding to the chosen belt length.

For equal diameter pulleys:

$$C = \frac{L - \pi \cdot d}{2}$$

For unequal diameter pulleys:

$$C \approx \frac{Y + \sqrt{Y^2 - 2(d_2 - d_1)^2}}{4}$$

$$\text{where: } Y = L - \frac{\pi \cdot (d_2 + d_1)}{2}$$

Step 5. Calculate The Number of Teeth in Mesh of the Small Pulley

Calculate the number of teeth in mesh z_m using the appropriate formula.

For two equal diameter pulleys:

$$z_m = \frac{z_p}{2}$$

For two unequal diameter pulleys:

$$z_m \approx z_{p1} \cdot \left(0.5 - \frac{d_2 - d_1}{2 \cdot \pi \cdot C} \right)$$

Step 6. Determine Pre-tension

The pre-tension T_i , defined as the belt tension in an idle drive, is illustrated as the distance between the belt and the dashed line in Figs. 1, 2, and 3. The pre-tension prevents jumping of the pulley teeth during belt operation. Based on experience, timing belts perform best with the slack side tension as follows:

$$T_2 = (0.1, \dots, 0.3) \cdot T_e$$

Drives with a fixed center to center distance

Drives with fixed center distances have the position of the adjustable shaft locked after pre-tensioning the belt (see Figs. 1 and 3). Assuming tight and slack side tensions are constant over the respective belt lengths, and a minimum slack side tension in the range of the above relationship (uni-directional load only), the pre-tension is calculated utilizing the following equation:

$$T_i = T_2 + T_e \cdot \frac{L_1}{L}$$

where: L = belt length = $L_1 + L_2$

L_1 = tight side belt length

L_2 = slack side belt length

U.S. units: L_1 [ft], and L_2 [ft].

Metric units: L_1 [m], and L_2 [m].

Drives with a fixed center to center distance are used in linear positioning, conveying and power transmission applications. In linear positioning applications, the maximum tight side length is inserted in the equation above.

The pre-tension for drives with a fixed center distance can also be approximated using the

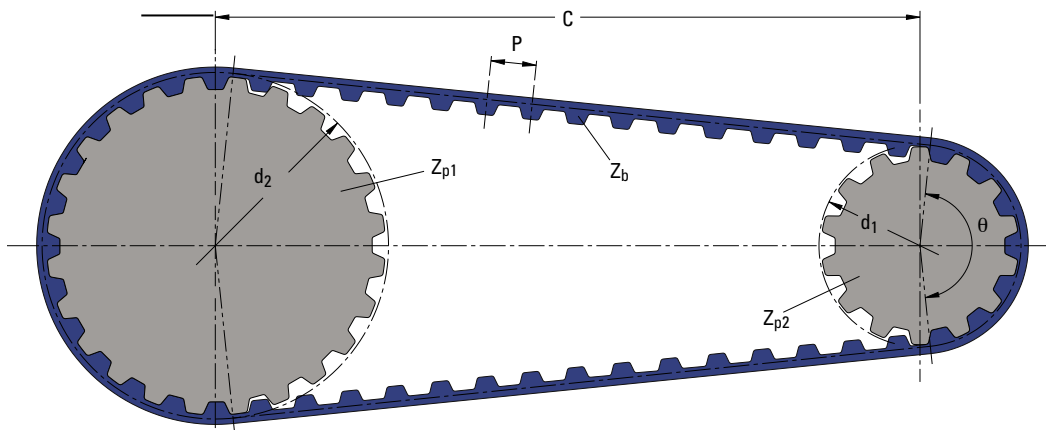

Fig. 4

Calculation

following formulas:

Conveying

(see Figs. 1 and 2)

$$T_i = (0.45, \dots, 0.55) \cdot T_e$$

Linear Positioning

(see Fig. 3)

$$T_i = (1.0, \dots, 1.2) \cdot T_e$$

$$T_i = (1.0, \dots, 2.0) \cdot T_e \Rightarrow \text{for ATL series only}$$

Drives with a constant slack side tension

Drives with constant slack side tension have an adjustable idler, tensioning the slack side, which is not locked (Figs. 2 and 5). During operation, the consistency of the slack side tension is maintained by the external tensioning force, F_e . Drives with a constant slack side tension may be considered for some conveying applications, they have the advantage of minimizing the required pre-tension.

The minimum pre-tension can be calculated from the analysis of the forces at the idler in Fig. 5:

$$T_i \approx T_2 = \frac{F_e}{2 \cdot \sin \frac{\theta_e}{2}}$$

where θ_e is the wrap angle of the belt around the back bending idler (Fig. 5).

Step 7. Calculate Tight Side Tension and Slack Side Tension

Conveying

(see Figs. 1 & 2)

The tight side tension T_1 and the slack side tension

T_2 are obtained by:

$$T_1 \approx T_i + T_e$$

$$T_2 = T_1 - T_e$$

Linear Positioning

(see Fig. 3)

The maximum tight side tension T_{1max} is obtained by:

$$T_{1max} \approx T_i + T_e$$

The respective minimum slack side tension T_{2min} is obtained by:

$$T_{2min} \approx T_i - T_e$$

for a fixed center distance.

Step 8. Calculate Belt Width

Determine the allowable tension T_{1all} for the cords of a 1" (or 25 mm) wide belt of the selected pitch given in Table 1, page 8. Note that T_{1all} is different for open end (positioning) and welded (conveying) belts. Determine the necessary belt width to withstand T_{1max} :

$$b \geq \frac{T_{1max}}{T_{1all}} \cdot 25$$

U.S. units: T_1 [lb], T_{1all} [lb/in], b [in].

Metric units: T_1 [N], T_{1all} [N/25mm], b [mm].

Determine the allowable effective tension T_{eall} for the teeth of a 1" (or 25 mm) wide belt of the selected pitch given on page 8/9. Note that T_{eall} is different for open end (positioning) and welded (conveying) belts.

Use Table 3, page 53 (Tooth in Mesh Factor) that follows to determine the tooth-in-mesh-factor t_m corresponding to the number of teeth in mesh z_m .

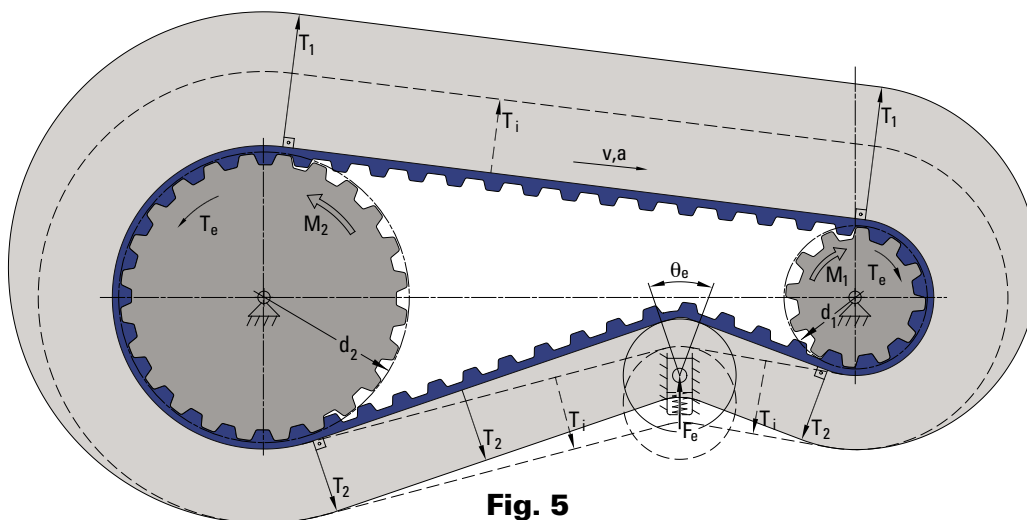

Fig. 5

Calculation

Determine the speed factor t_v using Table 4, page 54, (Speed Factor) that follows.

Calculate the width of the belt teeth b necessary to transmit T_e using the following formula:

$$b \geq \frac{T_e}{T_{eall} \cdot t_m \cdot t_v} \cdot 25$$

U.S. units: T_e [lb], T_{eall} [lb/in], b [in].

Metric units: T_e [N], T_{eall} [N/25mm], b [mm].

Select the belt width that satisfies the last two conditions, giving preference to standard belt widths. However, belts of nonstandard widths are also available.

The factors t_m and t_v prevent excessive tooth loading and belt wear.

The forces contributing to T_e , which in Step 1 were estimated, can now be calculated more accurately. Evaluate the contribution of these forces to the effective tension and, if necessary, recalculate T_e and repeat steps 6, 7 and 8.

For conveyors, the dimensions of the transported products will normally determine the belt width.

Step 9. Calculate Shaft Forces

Determine the shaft force F_{s1} at the driver pulley:

For angle of wrap $\theta = 180^\circ$:

$$F_{s1} = T_1 + T_2$$

For angle of wrap around the small pulley $\theta < 180^\circ$ (unequal diameter pulleys):

$$F_{s1} = \sqrt{T_1^2 + T_2^2 - 2T_1 \cdot T_2 \cdot \cos\theta}$$

$$\text{where } \theta = 2 \cdot \pi \cdot \left(0.5 - \frac{d_2 - d_1}{2 \cdot \pi \cdot C}\right)$$

Determine the shaft force F_{s2} at the idler pulley:

For angle of wrap $\theta = 180^\circ$:

$$F_{s2} = 2 \cdot T_2 \text{ when load moves toward the driver pulley, and}$$

$$F_{s2} = 2 \cdot T_1 \text{ when load moves away from the driver pulley.}$$

For angle of wrap around the small pulley

$\theta < 180^\circ$ (unequal diameter pulleys):

$$F_{s2} = 2 \cdot T_2 \cdot \sqrt{2 \cdot (1 - \cos\theta)} \text{ when load moves toward the driver and}$$

$$F_{s2} = 2 \cdot T_1 \cdot \sqrt{2 \cdot (1 - \cos\theta)} \text{ when the load moves away from the driver.}$$

Step 10. Calculate the Stiffness of a Linear Positioner

The total stiffness of the belt depends mainly on the stiffness of the belt segments between the pulleys. In most cases, the influence of belt teeth and belt cords in the tooth-in-mesh area can be ignored.

Calculate the resultant stiffness coefficient of tight and slack sides k , as a function of the slide position (Fig. 6).

$$k = c_{sp} \cdot b \cdot \frac{L}{L_1 \cdot L_2}$$

where: L_1 = tight side length

L_2 = slack side length

c_{sp} = specific stiffness (Table 1).

U.S. units: k [lb/in], c_{sp} [lb/in], b [in], L [in].

Metric units: k [N/mm], c_{sp} [N/mm], b [mm], L [mm].

Note that k is at its minimum when the tight and slack sides are equal.

Determine the positioning error Δx due to belt elongation caused by the remaining static force F_{st} on the slide:

$$\Delta x = \frac{F_{st}}{k}$$

In Fig. 6, for example, F_{st} is comprised of F_f and F_w and is balanced by the static effective tension T_{est} at the driver pulley.

Note that Δx is inversely proportional to the belt width. If you want reduced Δx , increase the belt width or select a belt with stiffer cords and/or with a larger pitch.

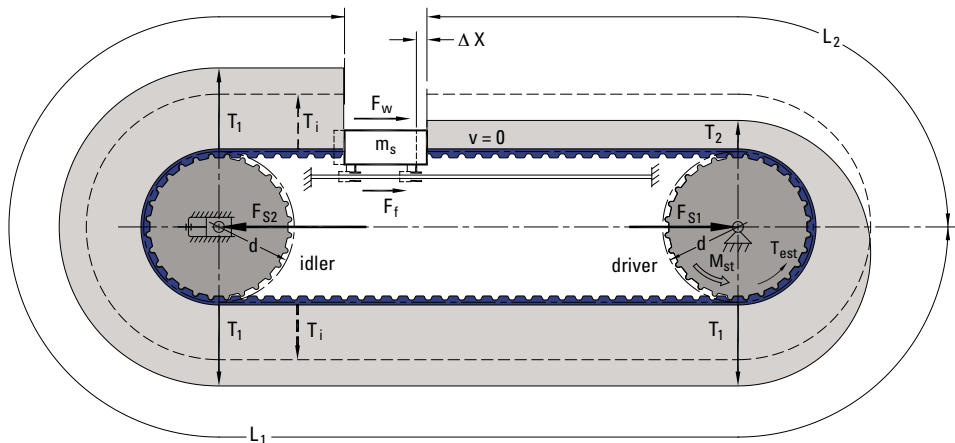
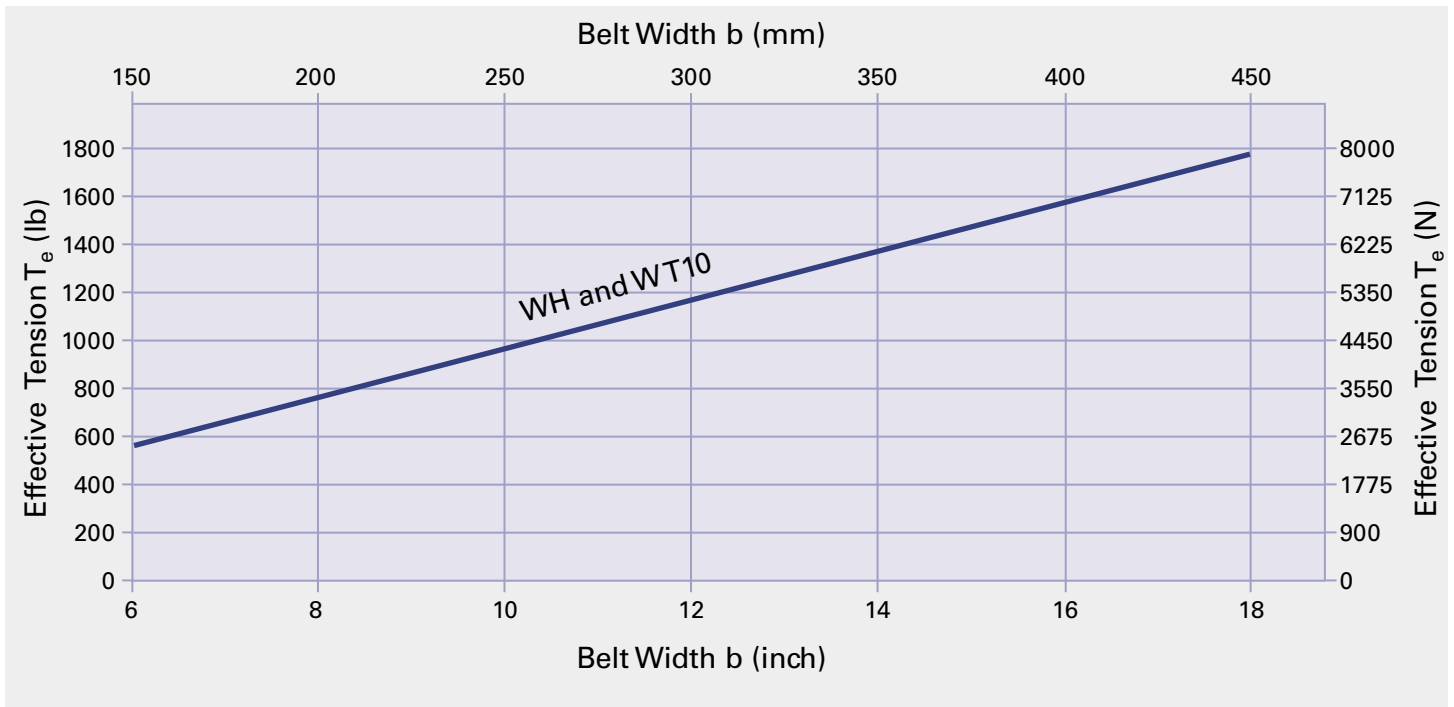

Fig. 6

Consult Application Engineering

Calculation



Graph 1

Tooth In Mesh Factor

No. of Teeth in Mesh Z_m	Tooth in Mesh Factor t_m
3	0.39
4	0.5
5	0.59
6	0.67
7	0.74
8	0.8
9	0.85
10	0.89
11	0.92
12	0.95
13	0.97
14	0.99
15	1

Table 3

Speed Factor

Speed		Speed Factor t_v
ft/min	m/s	
0	0	1
200	1	0.99
400	2	0.98
600	3	0.97
800	4	0.95
1000	5	0.93
1200	6	0.9
1400	7	0.87
1600	8	0.84
1800	9	0.81
2000	10	0.77

Table 4

Calculation

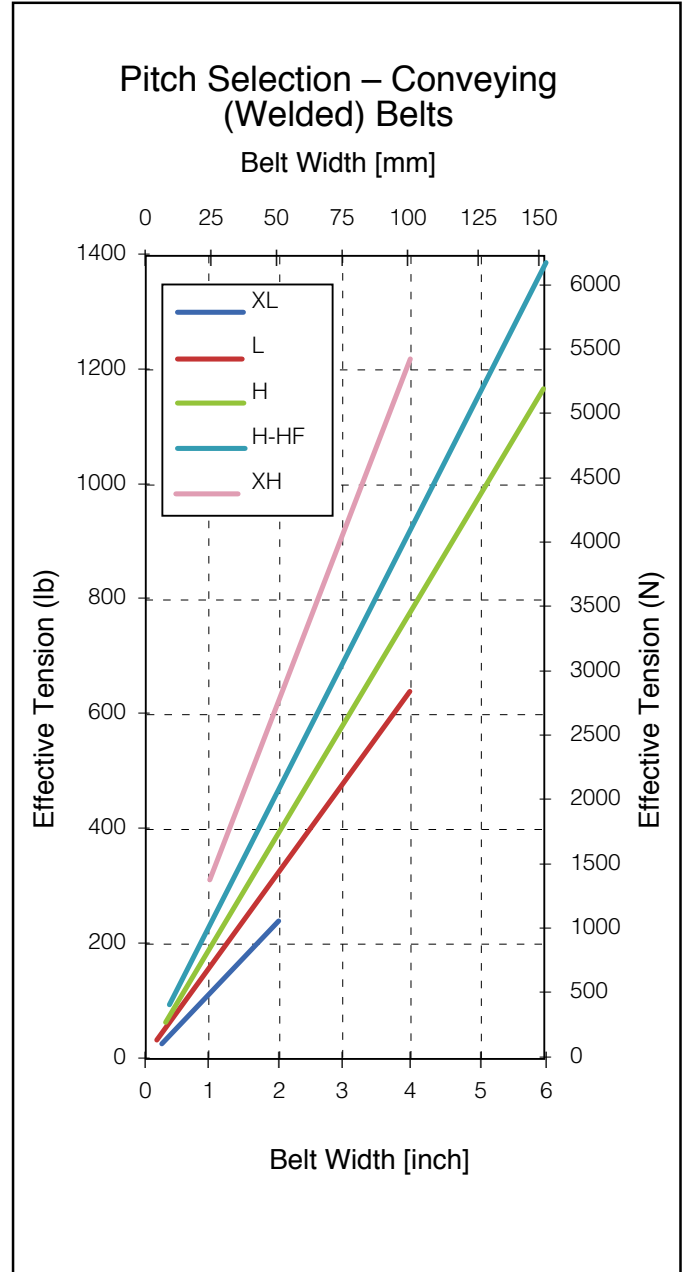
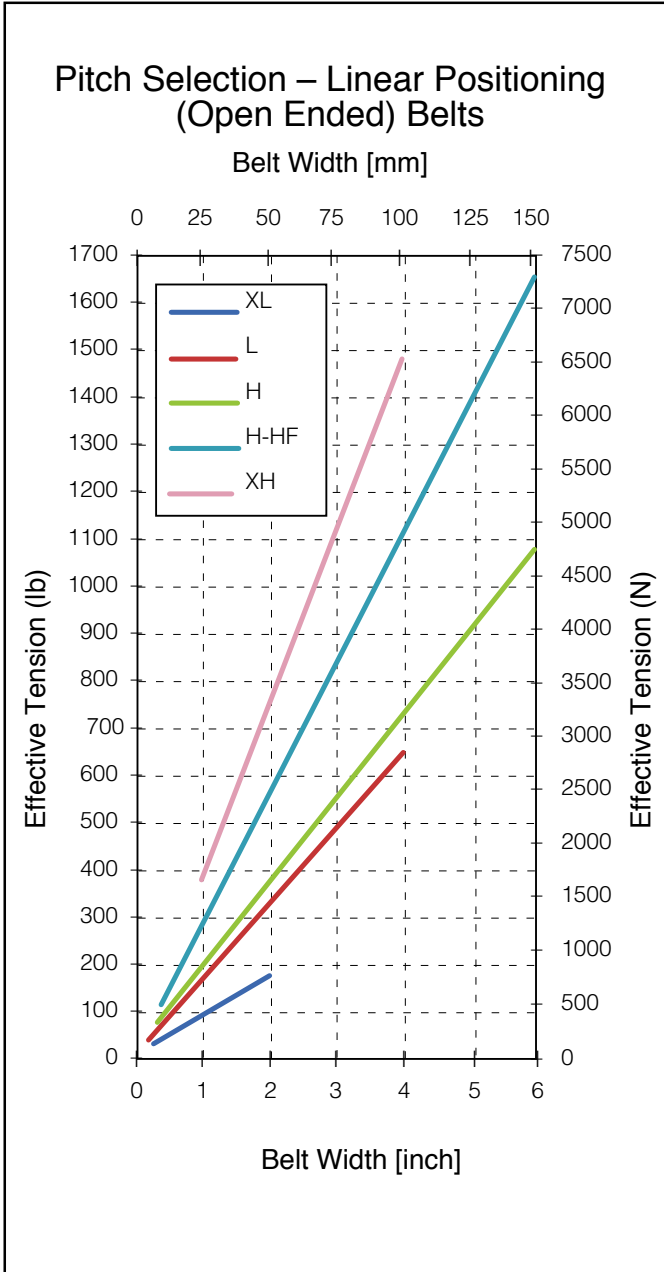

GRAPH 2a

Calculation

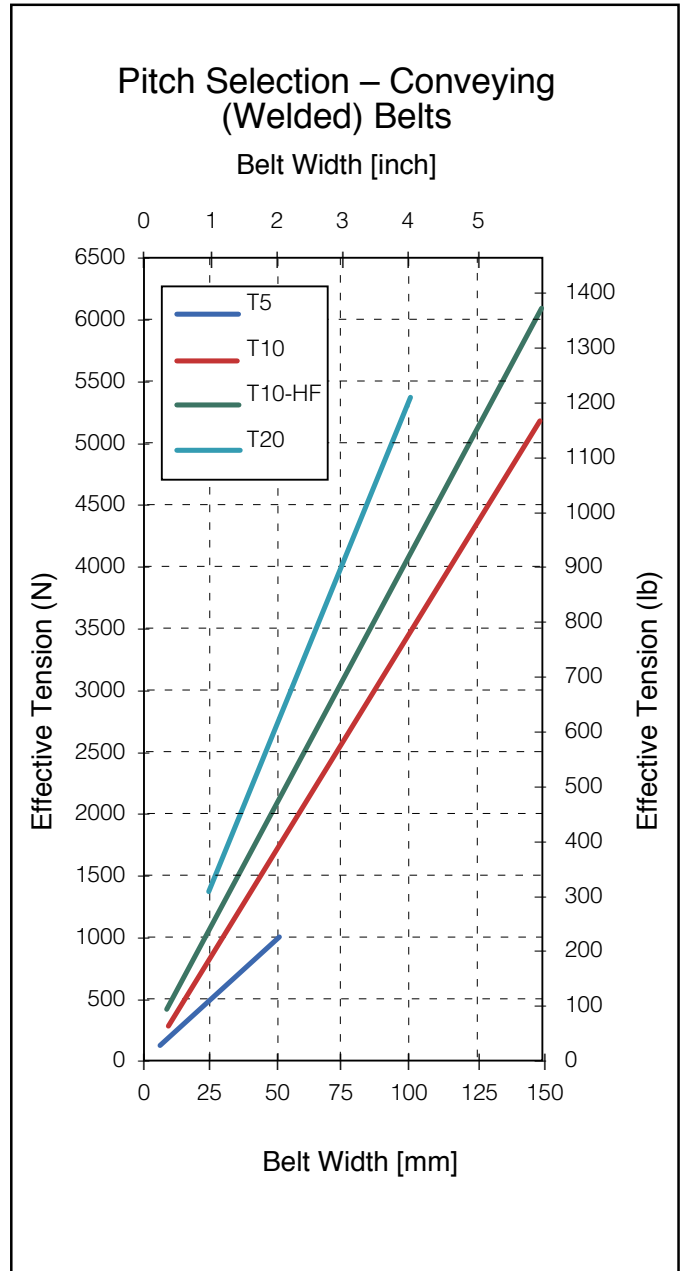
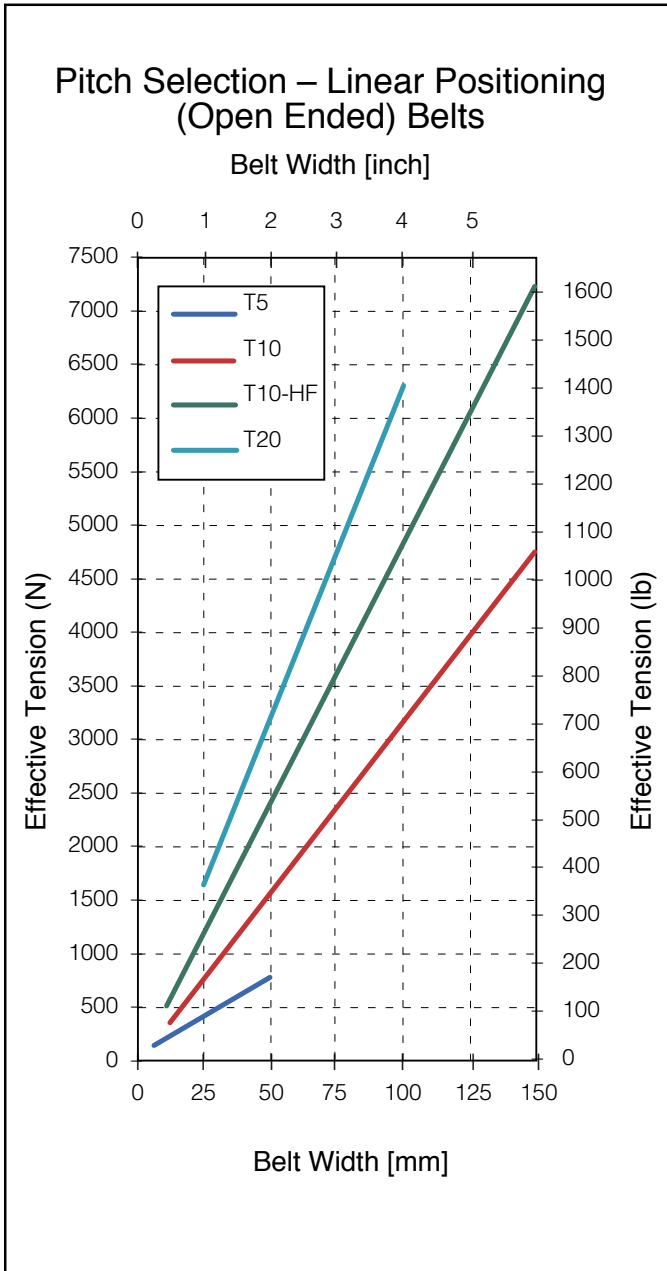

GRAPH 2b

Calculation

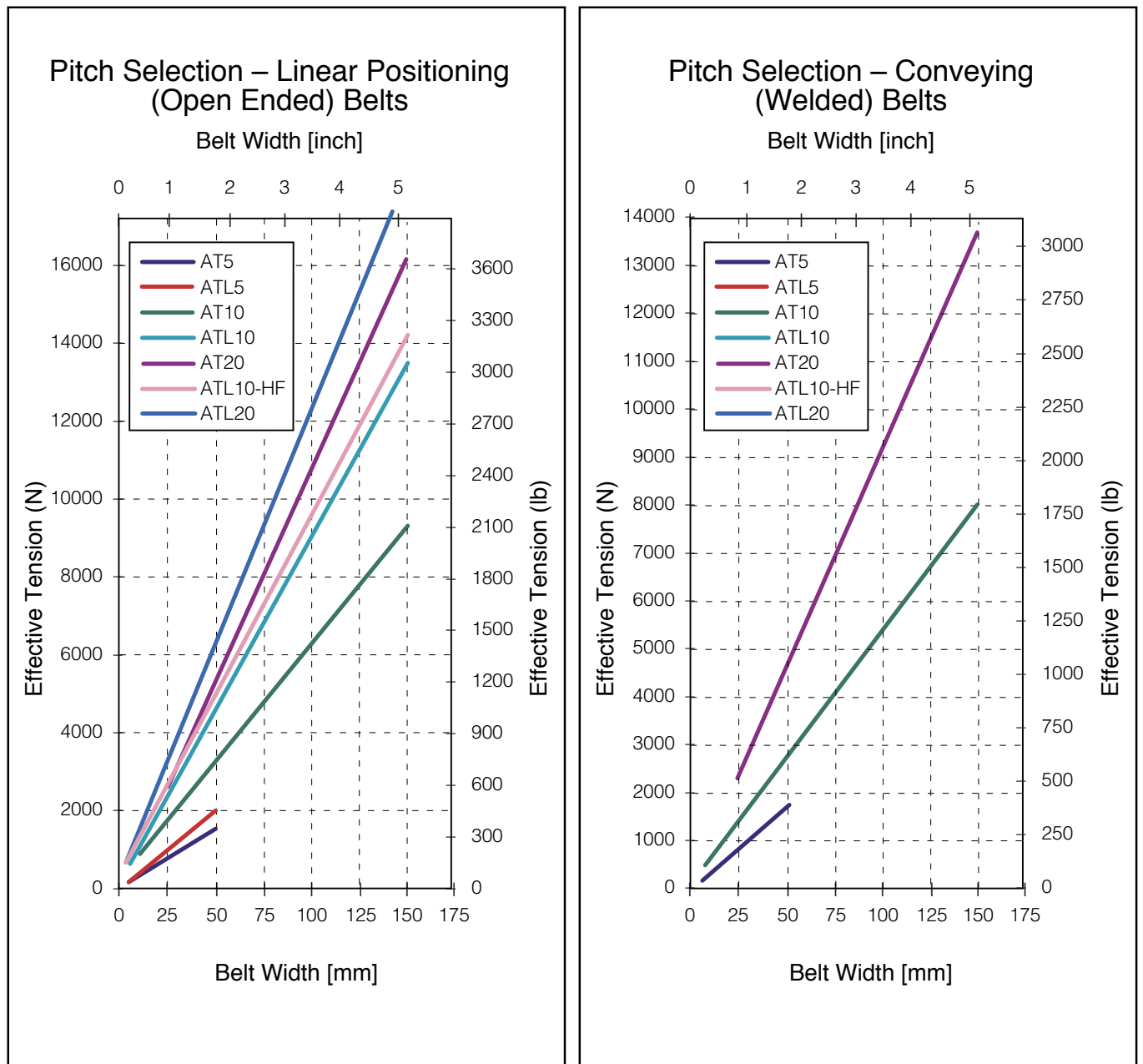

GRAPH 2c

Calculation

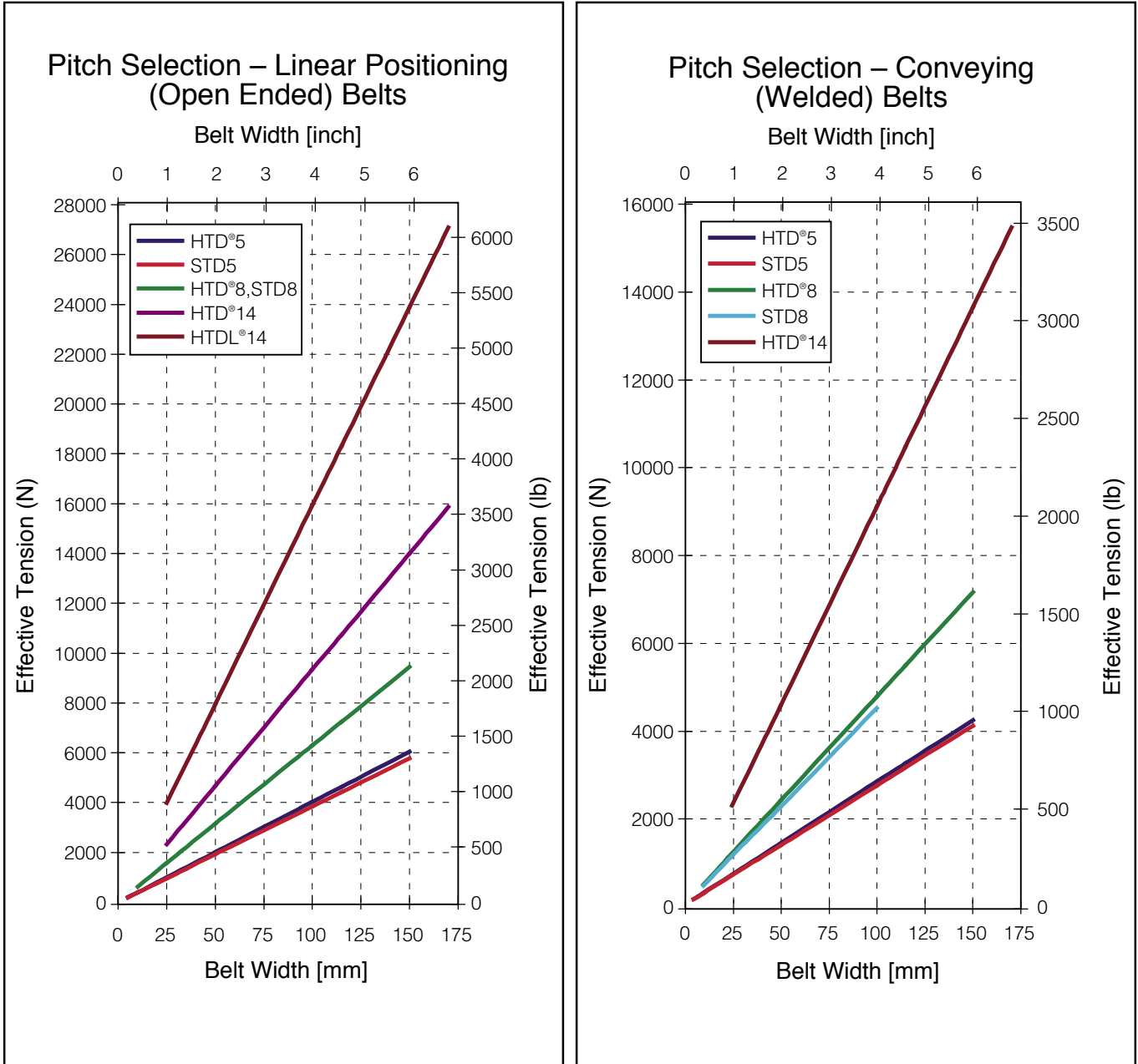

GRAPH 2d

Gates 507C Sonic Tension Meter

The Tension Meter determines correct belt tension – critical for belt peak performance.

Gates 507C Sonic Tension Meter

Proper belt installation is essential for optimum performance of synchronous belt drives. Gates' 507C sonic tension meter allows a simple and accurate tension measurement by analysing sound waves (natural frequencies) from the belt through the sensor. It processes the input signals and gives an accurate digital display of tension. This tester is compact, computerised and stores data for repetitive use measuring belt tension accurately time after time. Gates' sonic tension tester is supplied with a handy instruction manual.

Features

- Stores weight, width and span constants for up to ten different systems.
- New auto gain adjustment function cancels out background noise automatically.
- Shuts off automatically after five minutes of inactivity, making it an energy-saving device.
- Measurement range: 10 Hz to 5000 Hz.
- Flexible sensor (cord sensor and inductive sensor available on request).
- H 160 mm x D 26 mm x W 59 mm





Facilities

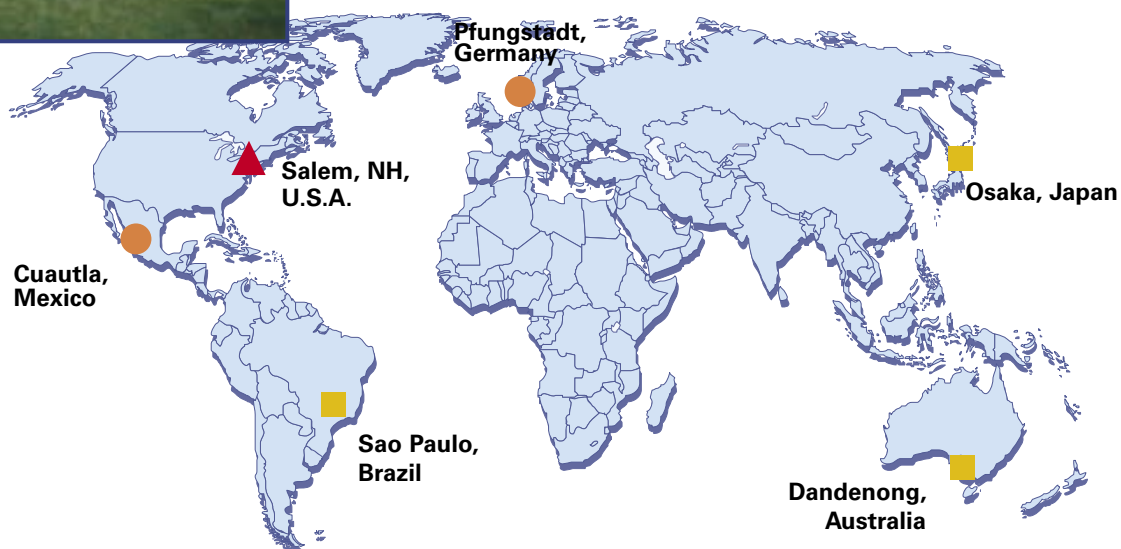

Headquarters



-  Headquarters, Sales & Manufacturing
-  Sales & Manufacturing
-  Sales

In November 2004, two leading belt manufacturers joined forces when Mectrol's polyurethane belt business was acquired by the Gates Corporation. The newly formed company, Gates Mectrol, has three manufacturing locations, all of which have achieved ISO 9001:2000

certification. Gates Mectrol has sales and applications engineering support in every major market through its own sales organization, its Gates Unitta joint venture and its partner fabricators.

Gates Mectrol is eager to serve you.

**USA
CORPORATE HEADQUARTERS**

Gates Mectrol, Inc.
9 Northwestern Drive
Salem, NH 03079, U.S.A.
Tel. +1 (603) 890-1515
Tel. +1 (800) 394-4844
Fax +1 (603) 890-1616
email: contact@gatesmectrol.com

EUROPE

Gates Mectrol GmbH
Werner von Siemens Strasse 2
64319 Pfungstadt, Germany
Tel. +49 (0) 6157-9727-0
Fax +49 (0) 6157-9727-272
email: info@gatesmectrol.de

MEXICO

Tomkins Poly Belt Mexicana S.A. de C.V.
Km. 96.5 Carr. Mexico
Cuautla No. 133
Cuautla Morelos Apartado
Postal 9 C.P. 62751, Mexico
Tel. +52 (735) 301-6042
Fax +52 (735) 353-1523
email: info@gatesmectrol.com.mx

AUSTRALIA

Gates Australia Pty Ltd.
1-15 Hydrive Close
South Dandenong, Victoria 3175, Australia
Tel. +61 (3) 9797-9688
Fax +61 (3) 9797-9600
email: southpacsales@gates.com

SOUTH AMERICA

Gates Do Brazil Ind. Com. Ltda
Av. Santa Maria, 600
Jacarei, SP 12328-320, Brazil
Tel. +55 (11) 3848-8122
Fax +55 (11) 3848-8170
email: gatesmkt@gatesbrasil.com.br

ASIA

Gates Unitta Asia Company
4-26 Sakuragawa 4-chome,
Naniwa-KU
556-0022 Osaka, Japan
Tel. +81 (6) 6563-1266
Fax +81 (6) 6563-1276
email: guatc@gates.com

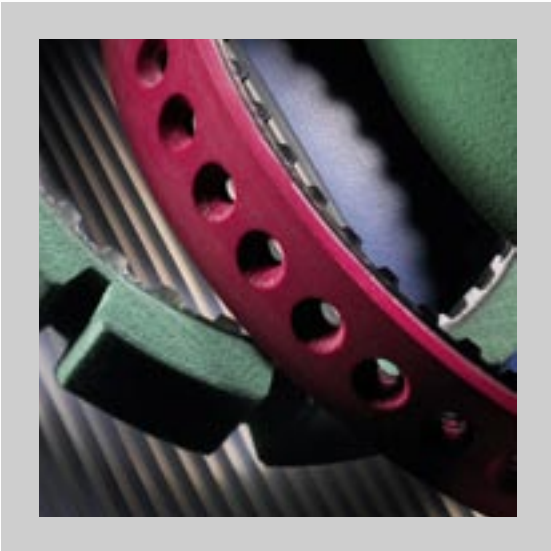
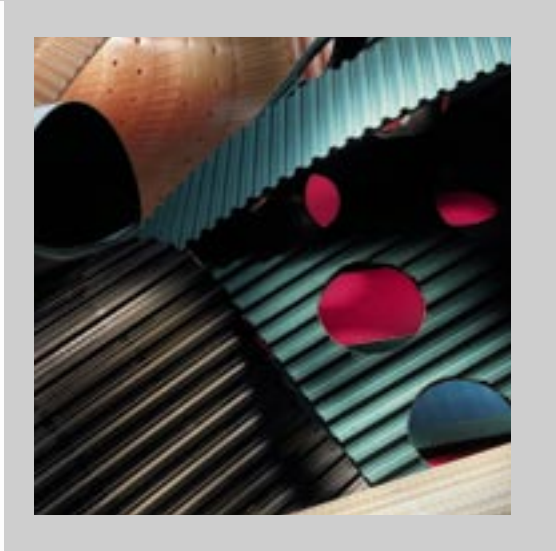
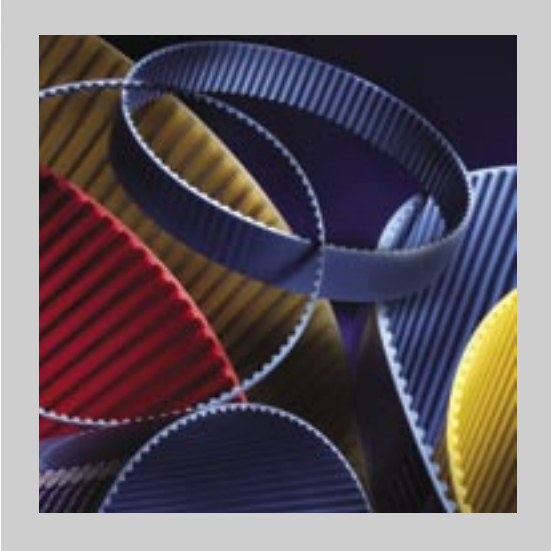

Gates Mectrol and Synchro-Power are registered trademarks. All other trademarks used herein are the property of their respective owners.

© Copyright 2007 Gates Mectrol Incorporated.
All rights reserved. 04/08

GM_UTB_04/08_A4_UK